

Part No. 190101-000

**USERS MANUAL  
FOR  
VIDEO TERMINAL  
MODEL CIT-101**



**C. Itoh Electronics, Inc.  
5301 Beethoven St.  
Los Angeles, CA 90066**

**November 1981**



## TABLE OF CONTENTS

Section	Page
I. INTRODUCTION .....	1-1
1.1 Product Description .....	1-1
1.2 Related Documents .....	1-1
1.3 Specifications .....	1-2
II. INSTALLATION .....	2-1
2.1 Introduction .....	2-1
2.2 Unpacking .....	2-1
2.3 Inspection for Damage .....	2-1
2.4 Identification .....	2-3
2.5 Safety Precautions .....	2-3
2.6 Installation .....	2-4
2.6.1 Locating the Terminal .....	2-4
2.6.2 Electrical Connections .....	2-4
2.6.2.1 Keyboard Cable Attachment .....	2-4
2.6.2.2 AC Line Voltage Connection .....	2-4
2.6.3 Terminal Checkout .....	2-5
2.6.4 Terminal Operational Configuration .....	2-5
2.6.4.1 Setting and Resetting SET-UP Bits .....	2-7
2.6.5 Interfacing .....	2-8
2.6.5.1 Communication Ports .....	2-8
2.6.5.2 Current Loop Interface .....	2-8
2.6.5.3 Communications Port Protocol .....	2-8
2.6.5.4 Bidirectional Auxiliary Port Protocol .....	2-13
2.7 Care and Maintenance .....	2-13
III. OPERATION .....	3-1
3.1 Introduction .....	3-1
3.2 Keyboard Description .....	3-1
3.2.1 Standard Keys .....	3-2
3.2.2 Terminal Control and Function Keys .....	3-2
3.2.2.1 Keyboard Cursor Control .....	3-5
3.2.3 Numeric Keypad .....	3-6
3.2.3.1 Normal Keypad Numeric Mode .....	3-6
3.2.3.2 Hex Keypad Numeric Mode .....	3-6
3.2.3.3 Numeric Keypad Application Modes .....	3-7
3.2.3.4 Bidirectional Auxiliary Port Keyboard Control .....	3-7
3.2.4 Indicators .....	3-9
3.2.5 CIT-101 Set-up Modes .....	3-10
3.2.5.1 Introduction .....	3-10
3.2.5.2 Common Set-Up Mode Features .....	3-10
3.2.5.3 Setting/Resetting Set-up Mode Bits .....	3-11

## TABLE OF CONTENTS (Continued)

Section	Page
3.2.6 CIT-101 Set-up Mode Operation .....	3-12
3.2.6.1 SET-UP A Mode .....	3-12
3.2.6.2 SET-UP B Mode .....	3-13
3.2.6.3 SET-UP C Mode .....	3-16
3.2.6.4 SET-UP D Mode .....	3-20
3.2.6.5 SET-UP Mode SAVE and RECALL Operations .....	3-23
3.2.7 Answerback Message .....	3-24
3.2.8 Self-test Diagnostics .....	3-25
3.2.8.1 Error Messages .....	3-25
3.2.8.2 User Troubleshooting .....	3-28
 IV. PROGRAMMING DATA .....	 4-1
4.1 Introduction .....	4-1
4.2 General .....	4-1
4.3 Keyboard Generated Codes .....	4-2
4.3.1 Keyboard Generated Standard Characters .....	4-2
4.3.2 Keyboard Generated Control Codes .....	4-4
4.3.3 Keyboard Function Key Control Codes .....	4-5
4.3.4 Cursor Keys .....	4-5
4.3.5 Numeric Keypad .....	4-6
4.3.6 Alternate Character Set .....	4-7
4.3.7 Graphics Character Set .....	4-9
4.3.8 Alternate Graphics Set .....	4-9
4.4 Control Sequences .....	4-11
4.4.0 ANSI Mode Control Sequences .....	4-11
4.4.1 Cursor Control Sequences .....	4-12
4.4.1.1 Relative Cursor Positioning .....	4-12
4.4.1.2 Direct Cursor Positioning .....	4-12
4.4.1.3 Scroll Direction .....	4-12
4.4.1.4 Save and Restore Cursor and Attributes .....	4-12
4.4.1.5 New Line .....	4-13
4.4.1.6 Cursor Attributes .....	4-13
4.4.2 Erase Control Sequences .....	4-13
4.4.2.1 Erase Within Display .....	4-13
4.4.2.2 Erase Window .....	4-13
4.4.2.3 Erase Within Line .....	4-14
4.4.2.4 Erase Window Line .....	4-14
4.4.3 Width/Height Line Commands .....	4-14
4.4.4 Video Attribute Commands .....	4-14
4.4.5 Scroll .....	4-15
4.4.5.1 Set Scrolling Region .....	4-15
4.4.5.2 Set Smooth Scroll Rate .....	4-15
4.4.6 Tabs .....	4-15

## TABLE OF CONTENTS (Continued)

Section	Page
4.4.7 Blink Attributes . . . . .	4-16
4.4.8 LED Control . . . . .	4-16
4.4.9 Modes . . . . .	4-16
4.4.10 Newline Mode . . . . .	4-16
4.4.11 Cursor Key Application Mode . . . . .	4-17
4.4.12 ASNI/VT52 Modes . . . . .	4-17
4.4.13 80/132 Column Modes . . . . .	4-17
4.4.14 Smooth/Jump Scroll Modes . . . . .	4-17
4.4.15 Reverse/Normal Screen Mode . . . . .	4-17
4.4.16 Cursor Origin Mode . . . . .	4-18
4.4.17 Auto Wraparound Mode . . . . .	4-18
4.4.18 Auto Repeat Mode . . . . .	4-18
4.4.19 Double Speed Smooth Scroll Mode . . . . .	4-18
4.4.20 VT52/VT100 Style Scroll Key Modes . . . . .	4-18
4.4.21 Hex Keypad Numeric Mode . . . . .	4-19
4.4.22 Clear Display/Line Feed on Form Feed Modes . . . . .	4-19
4.4.23 Disable Incoming XOFF Mode . . . . .	4-19
4.4.24 Screen Width Change Width Erase Mode . . . . .	4-19
4.4.25 Right Half of Double Width Lines Erase Mode . . . . .	4-20
4.4.26 Erase Page Extent Mode . . . . .	4-20
4.4.27 Tab Motion Spaces/Direct Modes . . . . .	4-20
4.4.28 CRT Saver Mode . . . . .	4-20
4.4.29 Half Duplex/Full Duplex Modes . . . . .	4-20
4.4.30 Set Time of Day Clock . . . . .	4-21
4.4.31 Reset Terminal . . . . .	4-21
4.4.32 Keypad Application Mode . . . . .	4-21
4.4.33 Option Line Attribute Bit . . . . .	4-21
4.4.34 Screen Alignment . . . . .	4-21
4.4.35 Keyclick . . . . .	4-22
4.4.36 Reports . . . . .	4-22
4.4.36.1 Request for Cursor Position . . . . .	4-22
4.4.36.2 Request for Cursor Position . . . . .	4-22
4.4.36.3 Request Device Attributes . . . . .	4-22
4.4.36.4 Request for Terminal Parameters . . . . .	4-23
4.4.37 Designate Character Set . . . . .	4-24
4.4.38 Bidirectional Auxiliary Port Control . . . . .	4-25
4.4.39 Summary of ANSI Control Sequences . . . . .	4-25
4.4.40 VT52 Mode Control Sequences . . . . .	4-30
4.4.40.1 Cursor Control Sequences . . . . .	4-30
4.4.40.2 Erase Control Sequences . . . . .	4-30
4.4.40.3 Graphics Mode . . . . .	4-30
4.4.40.4 Keypad Application Mode . . . . .	4-30
4.4.40.5 Hold Screen Mode . . . . .	4-31

## TABLE OF CONTENTS (Continued)

Section	Page
4.4.40.6 Bidirectional Auxiliary Port Control . . . . .	4-31
4.4.40.7 Scroll . . . . .	4-31
4.4.40.8 ANSI Mode . . . . .	4-31
4.4.40.9 Request Identity . . . . .	4-31
4.4.40.10 Summary of VT-52 Control Sequences . . . . .	4-32
4.4.41 ASCII Table . . . . .	4-33
4.4.42 Self-Test Diagnostics . . . . .	4-35
Subject Index . . . . .	4-36
APPENDIX A – ANSI DEFINITIONS . . . . .	A-1
APPENDIX B – DOT MATRIX CONFIGURATIONS . . . . .	B-1

## LIST OF ILLUSTRATIONS

Figure	Page
1-1 CIT-101 Display Terminal . . . . .	1-2
2-1 CIT-101 Unpacking . . . . .	2-2
2-2 CIT-101 Connectors and Controls . . . . .	2-6
2-3 Male D Connector Pin Locations . . . . .	2-9
2-4 Female D Connector Pin Locations . . . . .	2-10
2-5 Active Configuration, 20 mA Current Loop . . . . .	2-11
2-6 Passive Configuration, 20 mA Current Loop . . . . .	2-12
3-1 CIT-101 Keyboard . . . . .	3-1
3-2 CIT-101 Standard Keyboard Keys . . . . .	3-2
3-3 Terminal Control and Functioning Keys . . . . .	3-2
3-4 CIT-101 Numeric Keypad . . . . .	3-6
3-5 Portion of CIT-101 Keyboard . . . . .	3-9
3-6 SET-UP A Mode With Time-of-Day Clock Display . . . . .	3-12
3-7 SET-UP B Mode Display . . . . .	3-13
3-8 SET-UP C Mode Display . . . . .	3-17
3-9 SET-UP D Mode . . . . .	3-21
4-1 CIT-101 Data Flow . . . . .	4-1

## LIST OF TABLES

Table	Page
2-1 Communication D Connector Pin Assignments .....	2-9
2-2 Auxiliary Port D Connector Pin Assignments .....	2-10
3-1 CIT-101 Terminal Control and Function Keys .....	3-3
3-2 Numeric Keypad Generated Codes .....	3-7
3-3 Auxiliary Keypad Special Functions .....	3-8
3-4 Keyboard Indicator Functions .....	3-9
3-5 SET-UP B Mode Control Conditions .....	3-13
3-6 SET-UP B Mode Control Condition Options .....	3-15
3-7 SET-UP C Mode Control Conditions .....	3-17
3-8 SET-UP C Mode Control Condition Options .....	3-18
3-9 SET-UP D Mode Control Conditions .....	3-21
3-10 SET-UP D Mode Control Condition Options .....	3-22
4-1 CIT-101 Keyboard Generated Standard Character Codes .....	4-2
4-2 Keyboard Generated Control Codes .....	4-4
4-3 Function Keys Control Codes .....	4-5
4-4 Cursor Control Key Control Sequences .....	4-5
4-5 Numeric Keypad Generated Codes .....	4-6
4-6 CIT-101 Alternate Character Set and Octal Codes .....	4-7
4-7 The Graphics Character Set .....	4-9
4-8 Alternate Graphics Character Set .....	4-10
4-9 Summary of ANSI Mode Control Sequences .....	4-25
4-10 Summary of VT52 Mode Control Sequences .....	4-32
4-11 Standard 7-Bit ASCII Code .....	4-33





This document reflects the features and specifications of the CIT-101. C. Itoh Electronics reserves the right to make changes and improvements in features and specifications at any time without prior notice or obligation.

The following are trademarks or equipment designations of C. Itoh Electronics, Inc.

CIT-101

The following are trademarks or equipment designations of the Digital Equipment Corporation, Maynard, Massachusetts.

DEC  
VT52  
VT100  
VT103

## PREFACE

This is the Users Manual for the C. Itoh CIT-101 Video Data Terminal. The objective of this manual is to provide the CIT-101 user the necessary information with which to install and use the CIT-101 Video Data Terminal. The manual is comprised of four sections (Introduction, Installation, Operation and Programming Data), an index, a glossary of terms (Appendix A), and dot matrix configurations (Appendix B).

## **SECTION I INTRODUCTION**

### **1.1 PRODUCT DESCRIPTION**

The CIT-101, figure 1-1, is a versatile, low cost, multifunction Video data terminal with a detachable keyboard. The CIT-101 allows the user to communicate with a host computer system via the keyboard and display screen. The CIT-101 can be interfaced with a variety of computer systems and peripheral devices.

The CIT-101 is directly interchangeable with the Digital Equipment Corporation (DEC) VT-100 Video Terminal. The CIT-101 can operate in one of two modes, ANSI or VT52. In ANSI mode the CIT-101 is compatible with American National Standards Institute (ANSI) programming standards. In the VT52 mode the CIT-101 is software compatible with DEC VT-52 Terminals.

Standard features include a full and half duplex communication channel, RS232-C or 20 mA current loop communication interface, an alternate character set, and a composite video output.

Optional features available from the manufacturer are, a full duplex (bidirectional) auxiliary port and a choice of CRT Phosphor.

### **1.2 RELATED DOCUMENTS**

All CIT-101 documentation should be ordered from the C. Itoh Documentation Center.

Available documentation includes:

- CIT-101 Users Manual
- CIT-101 Maintenance Manual

SECTION I  
INTRODUCTION

1.1. PRODUCT DESCRIPTION

The CIT-101, (Figure 1-1), is a versatile, low cost, multi-function Video data terminal with a detachable keyboard. The CIT-101 allows the user to communicate with a host computer system via the keyboard and display screen. The CIT-101 is compatible with a variety of computer systems and peripheral devices.

The CIT-101 is designed for use as a terminal for a host computer system. The CIT-101 is compatible with American National Standards Institute (ANSI) programming standards. The CIT-101 is software compatible with the following software packages:

Standard features include a full duplex communication channel, a video display, a keyboard, a printer set, and a composite video output. Optional features include a choice of CRT Projection or Cathode Ray Tube (CRT) display.

1.2. RELATED DOCUMENTS

All CIT-101 documentation should be ordered from the CIT-101 User Manual. Available documentation includes:



Figure 1-1. CIT-101 Video Terminal

### 1.3 SPECIFICATIONS

Physical dimensions, environmental requirements, and certain functional characteristics of the CIT-101 terminal are contained in this listing.

#### DIMENSIONS

Monitor	Width	18.25 inches (464 mm)
	Height	14.60 inches (371 mm)
	Depth	14.50 inches (369 mm)
Keyboard	Width	18.25 inches (464 mm)
	Height	3.54 inches (90 mm)
	Depth	7.85 inches (200 mm)

#### WEIGHT

Monitor	31.8 lbs (14.4 Kg)
Keyboard	4.6 lbs (2.1 Kg)
Combined Shipping	42 lbs (18.7 Kg)

#### ENVIRONMENTAL CONSIDERATIONS

Operating	Temperature:	40 to 105 F (5 to 40 C)
	Humidity:	10% to 90% Relative (non-condensing)
Non-operating	Temperature:	-5 to +140 F (-20 to +60 C)
	Humidity:	0% to 95% Relative (non-condensing)

#### NOTE

The CIT-101 should not be operated continuously under temperature conditions exceeding 95°F (35°C).

#### POWER

AC Input Voltage:	90-128 Volt or 180-256 Volt (Switch Selectable)
Input Power (Max):	90 watt
Input Frequency:	47-63 Hz
Phase/Wire:	Single-Phase, 3-Wire
AC Leakage Current:	Less Than 0.25 mA
Power Cord:	Detachable, 6 Feet (1.6 m)

## DISPLAY

Cathode Ray Tube: 12" Diagonal, 16 MHz, Non-Glare Screen

Display Format:

SH SW 80C:	80 columns x 24 lines
SH SW 132C:	132 columns x 24 lines
SH DW 80C:	40 columns x 24 lines
SH DW 132C:	66 columns x 24 lines
DH SW 80C:	80 columns x 12 lines
DH SW 132C:	132 columns x 12 lines
DH DW 80C:	40 columns x 12 lines
DH DW 132C:	66 columns x 12 lines

**Note:** SW = single width  
DW = double width  
SH = single height  
DH = double height

Character Generation: 8 x 10 stored character cell displayed left justified in 10 x 10 display cell for 80 columns, and 9 x 10 display cell for 132 columns. Right-most bit of character cell is replicated through right-most bit of display cell. Standard character set uses principally 7 x 9 Characters with descenders and occasional wide body 9 x 9 characters. Standard and optional graphics utilize last column hardware.

Raster Scan: 15,600 Hz horizontal, selectable 50/60 Hertz vertical, repeat field

Character Set(s): Extended 96 Character ASCII with 32 standard graphic characters and optional alternate 128 character set

Cursor: Keyboard Selectable: Blinking Block or Blinking Underline, Solid Block or Solid Underline, or Invisible (no cursor)

Active Display Size: Approximately 220 mm x 125 mm

## **KEYBOARD**

<b>General:</b>	85-key detachable unit with built-in 1.6m (6 ft.) coiled cord
<b>Number of Keys:</b>	Auxiliary Keypad 18 Data keys 48 Function and multiple mode keys 19
<b>Key Style:</b>	Sculptured
<b>Key Control:</b>	Two Key Roll-over minimum
<b>Visual Indicators:</b>	7 LEDs with designated functions:  1 ON LINE and blinking XOFF Holding 1 OFF LINE (LOCAL) 1 Keyboard Locked 4 User programmable and diagnostic
<b>Audible Signals:</b>	User settable Key-click  Bell tone  1) Generated by pushing CTRL and G (BELL) keys simultaneously. 2) If MARGIN BELL is enabled, sounds when cursor is 8 characters from right screen margin 3) On power-up, first bell signals keyboard is operational and second bell reports results of self-test diagnostics (standard length bell = test OK; long bell = self-test error found)
<b>Key Layout:</b>	Modified ANSI standard 67 key arrangement with auxiliary 18 key numeric keypad.
<b>Auxiliary Keypad:</b>	18 keys with 10 numerals, PERIOD, COMMA, MINUS, ENTER, and 4 Special Function keys. In Hex Keypad Numeric Mode, six keys (PF1, PF2, PF3, PF4, MINUS, and COMMA) become A through F, respectively.

## COMMUNICATION PORT INTERFACE

Type:	EIA (RS232-C) or 20/60 ma current loop (see note below)
Speeds (Baud Rates):	2, 10, 50, 75, 110, 134.5, 150, 200, 300, 600, 1200, 1800, 2000, 2400, 3600, 4800, 7200, 9600, 19200 (Keyboard selectable)
Code:	7 or 8 bit ASCII (Keyboard selectable)
Serial Data Protocol:	Asynchronous with XON-XOFF and EIA RTS-CTS handshake (Keyboard selectable)
Character Length:	7 or 8 Bits (Keyboard selectable)
Parity:	Even, Odd, or None (Keyboard selectable)
Stop bits:	1 or 2 (Keyboard selectable)
Handshake:	Reception: automatic XON & XOFF (Keyboard selectable) (Required only at 19.2K baud).  Transmission: Automatic XON & XOFF (Keyboard Selectable) and Request to Send – Clear to Send (Keyboard Selectable)
Duplex:	Half Duplex or Full Duplex (Keyboard selectable)
Connector:	25 Pin D connector (female socket, male pins)
Electrical Protocol:	20/60 ma current loop (active or passive) or EIA RS232-C (connector programmable).

### NOTE

Only one of either the Communication Port or the Auxiliary Port may be configured for current loop transmit and only one Port may be configured for current loop receive at a time.

Output RS232-C levels	Mark level (unasserted state) -6.0 V to -12.0 V. Space (asserted level) 6.0 V to 12.0 V.
Input RS232-C levels	Mark level (unasserted state) -25.0 V to 0.75 V or open circuit. Space level (asserted state): 2.25 V to 25.0 V.



## AUXILIARY PORT INTERFACE

Type:	EIR RS232-C or 20 mA current loop
Baud rates:	50, 75, 110, 134.5, 150, 200, 300, 600, 1200, 1800, 2000, 2400, 3600, 4800, 7200, 9600, and 19200 baud (Keyboard selectable)
Code:	7 or 8 bit ASCII (Keyboard selectable)
Serial Data Protocol:	Asynchronous
Character Length:	7 or 8 Bits (Keyboard selectable)
Parity:	Even, Odd, or None (Keyboard selectable)
Stop bits:	1 or 2 (Keyboard selectable)
Handshake:	Reception: Automatic XON-XOFF (Keyboard selectable). Data Terminal Ready (DTR) handshake.  Transmission: Automatic XON-XOFF (Keyboard selectable)
Duplex:	Full duplex
Connector:	25 Pin D connector (male socket, female pins)

### NOTE

Only one Port at one time may be in the current loop receive or transmit configuration. Both Ports cannot be in the same configuration.

Output RS232-C Levels: Mark level -6.0 V to -12.0 V. Space level 6.0 V to 12.0 V.

Input RS232-C Levels: Mark level -25.0 V to 0.75 V or open circuit. Space level 2.25 V to 25.0 V.



## **SECTION II INSTALLATION**

### **2.1 INTRODUCTION**

Section II describes the unpacking and installation procedures for the CIT-101. A brief description of the terminal configuration and factory default condition is provided.

### **2.2 UNPACKING**

The CIT-101 is shipped complete in one shipping container. Refer to the following steps and figure 2-1 to unpack the CIT-101.

1. Place CIT-101 shipping carton on level surface.

#### **NOTE**

Ensure carton has correct side up according to locator arrows on carton.

2. Open top of carton and carefully remove contents as shown in figure 2-1.
3. Ensure the following items are contained in carton:
  - a. Keyboard module
  - b. Video terminal module
  - c. AC line cord.
4. After unpacking and inspection for shipping damage, installation procedures may be performed.

#### **NOTE**

Retain all packing and shipping materials.

### **2.3 INSPECTION FOR DAMAGE**

Carefully check each component for any signs of shipping damage. All shipping containers have been specially designed to protect their contents and special care has been taken to prevent damage under normal shipping conditions. Mishandling should be evident upon the inspection of the shipping container. If damage is found after visual inspection, take care not to destroy the evidence. If necessary, document the damage with photographs and contact the transport carrier immediately.

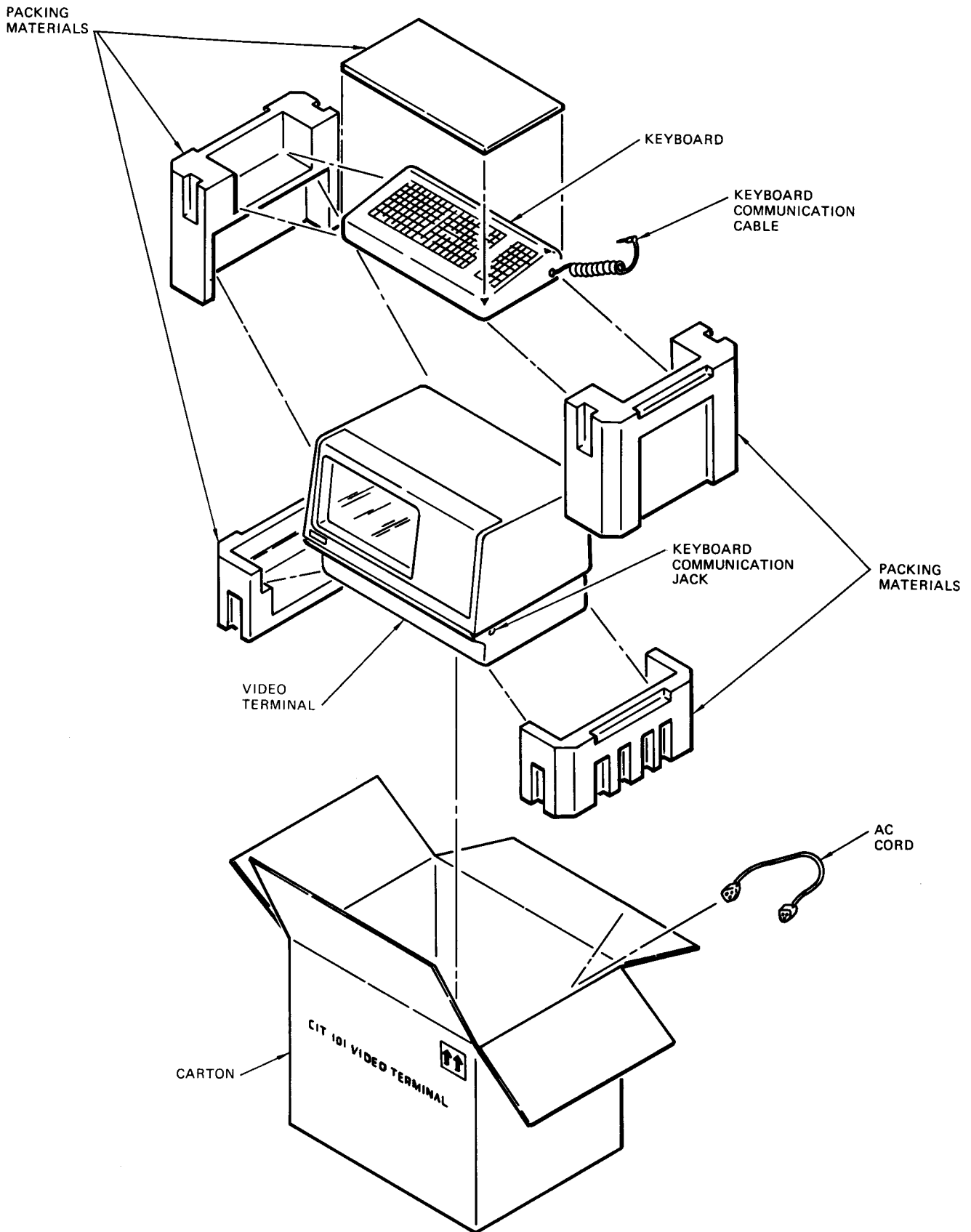

Figure 2-1. CIT-101 Unpacking

## 2.4 IDENTIFICATION

The CIT-101 Video Data Terminal is identified by a 3 character alphanumeric part number, which is printed on each shipping carton and breaks down as follows:

A B C

The first character (A) indicates the power supply input voltage:

<u>A</u>	<u>VOLTAGE</u>
1	115
2	230

The second character (B) indicates the CRT phosphor type:

<u>B</u>	<u>PHOSPHOR COLOR</u>
1	P31 (Green)
4	P4 (Black/White)
L	P22 (Amber)

The third character (C) indicates the presence or absence of RS232C Auxiliary Port:

<u>C</u>	<u>RS232C AUXILIARY PORT</u>
0	Absent
1	Present

For example, the standard CIT-101 has the part number '140'.

This part number indicates the CIT-101 has been configured as follows:

- 1 indicates 115 volts
- 4 indicates P4 phosphor
- 0 indicates no RS232C auxiliary port

## 2.5 SAFETY PRECAUTIONS

Under normal operating conditions, no special safety precautions are required.

## 2.6 INSTALLATION

### 2.6.1 LOCATING THE TERMINAL

The location of the CIT-101 in a working environment should conform to the environmental operating specifications outlined in Section I. However, the operational reliability of the CIT-101 requires the operator to adhere to the following guidelines:

1. Locate the CIT-101 such that there is free air flow through top and bottom air vents.
2. Do not place working material on the CIT-101 air vents.
3. Do not locate the CIT-101 where it is exposed to sunlight or intense heat.

### 2.6.2 ELECTRICAL CONNECTIONS

The following two electrical connections must be made in order to operate the terminal:

The coiled Keyboard cable and the AC line cord must be connected to the terminal.

**2.6.2.1 Keyboard Cable Attachment.** Plug keyboard cable connector into jack located at lower right corner of the video terminal, refer to figure 2-1.

**2.6.2.2 AC Line Voltage Connection.** Verify that the CIT-101 AC line switch setting is set to value of voltage supplied, refer to figure 2-2. If the AC line switch is not set to the proper voltage, perform the following:

#### **CAUTION**

Do not attempt to operate the CIT-101 with an incorrect AC voltage setting or damage to the CIT-101 can occur.

1. Remove two phillips screws on protective cover of AC line switch.
2. Remove cover and set slide switch to value of AC voltage supplied.
3. Install protective cover and two screws removed in step 1.
4. Connect AC cord to AC receptacle at rear of video terminal. Plug AC cord into desired AC outlet.

### **2.6.3 TERMINAL CHECKOUT**

Apply power using the power ON/OFF switch located on the rear of the terminal as shown in Figure 2-2. The CIT-101 should immediately respond with a beep tone, a pause of about 3 seconds, and a second beep of equal length. If the second beep is of the same duration as the first and no message appears on the screen, your unit has successfully completed self-test and is ready for connection to a host computer and terminal configuration. Refer to Section III SET-UP Modes, for more information about configuring the CIT-101 for your computer.

If no beep tone is heard or the second beep is longer than the first (about twice as long), the CIT-101 diagnostics have detected a fault condition. After the CRT has warmed up, a message will appear in the upper left corner of the screen giving more information about the problem. See Section III of this *User's Guide* covering Self-Test for more information and possible corrective action. Contact your local service representative for corrective action if a fault should occur.

### **2.6.4 TERMINAL OPERATIONAL CONFIGURATION**

The operational configuration (SET-UP) of the CIT-101 is achieved via either the keyboard or host computer. Since the SET-UP parameters may be permanently stored in NVR memory (no loss of data occurs during power off), standard default conditions may be programmed into the NVR memory at the factory. These default conditions for each SET-UP mode are displayed on the screen after power on and selection of the desired SET-UP mode.

To select a particular SET-UP mode, the CIT-101 must first be put in SET-UP mode by pushing the SET-UP key, which puts the terminal in the SET-UP A mode. To advance the terminal to SET-UP B and then to SET-UP C modes, simply press the %5 key. From SET-UP C mode, pressing the %5 key will return the terminal to SET-UP A mode, unless the bidirectional auxiliary port is installed, in which case the terminal will advance to SET-UP D mode.

Section III of this manual contains a full description of the four SET-UP modes, their respective displays, factory default values, as well as their operation and the methods for either saving operator selected SET-UP parameters or restoring factory default conditions.

A short description of setting and resetting any SET-UP bit, in any mode, follows. For additional SET-UP information, please refer to Section III.

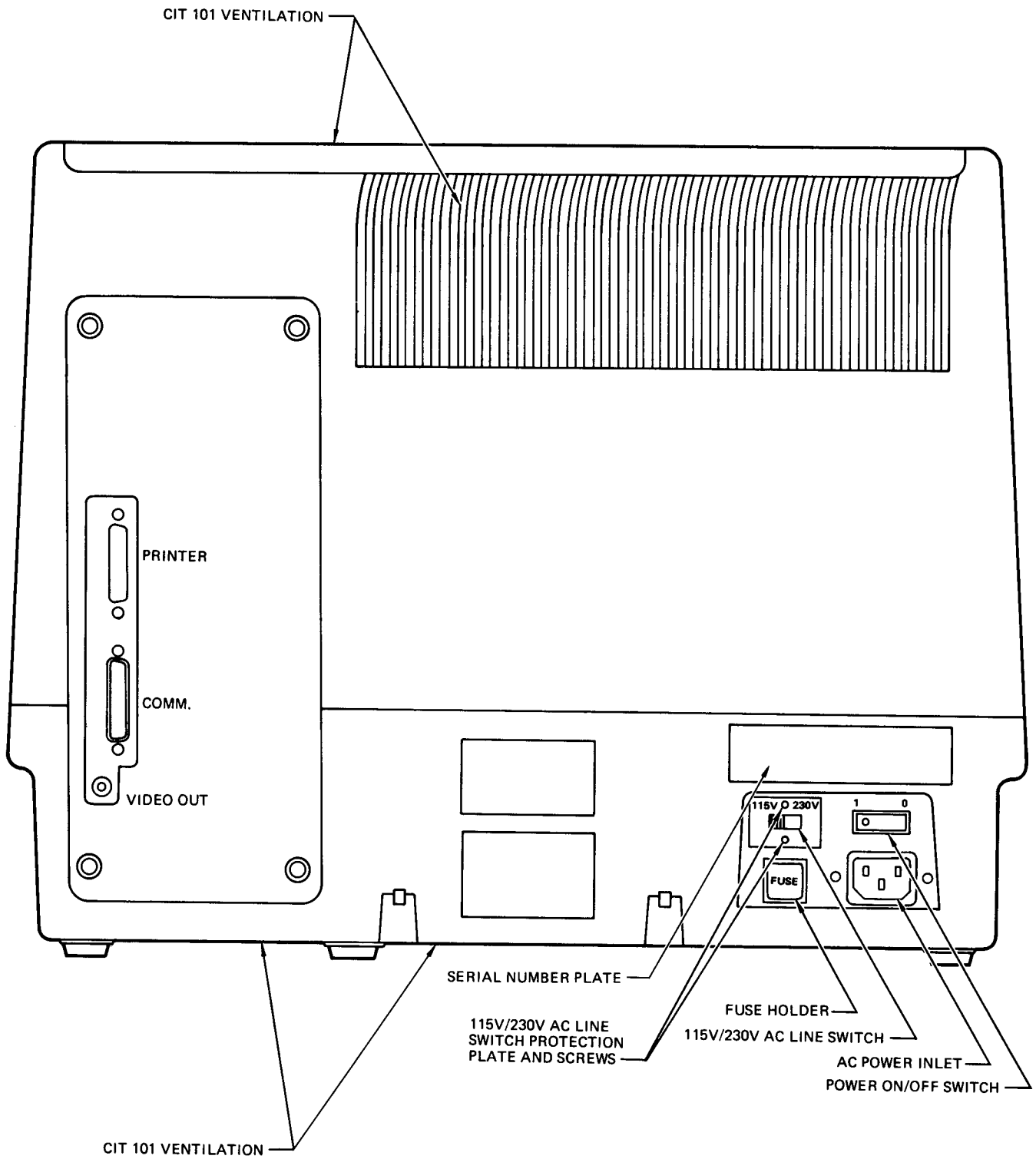

Figure 2-2. CIT-101 Connectors and Controls



**2.6.4.1 Setting and Resetting SET-UP Bits.** The purpose in having SET-UP bits is to provide an easy method for changing various operating conditions of the terminal. Neglecting SET-UP A mode (which provides a tabbing function), SET-UP B mode controls 20 conditions, SET-UP C mode controls 15 conditions and SET-UP D mode controls 11 conditions, a total of 46 controllable conditions. Section III contains detailed information and procedures for each of the four set-up modes. To change any controllable condition requires the following general sequence of operations:

1. Turn power on.
2. Press SET-UP key (SET-UP A mode will be displayed).
3. Advance sequentially to desired SET-UP mode by pressing the %5 key for each mode advance.
4. Position cursor to condition to be changed by pressing → key or SPACE BAR for left to right movement or ← key for right to left movement.
5. To alter (toggle) the condition to be changed press the ^6 key.
6. Leave the SET-UP mode by pressing SET-UP key again.

For example, to change the screen background (from dark-to-light or light-to-dark) would require the following.

1. Turn power on (if not already on).
2. Press SET-UP key.
3. To change background (bit 3 of group 1 in SET-UP B mode) the ^6 key must be toggled, (see Table 3-6). Therefore, the terminal must be in SET-UP B mode; press %5 key once after pressing SET-UP key. Terminal will display SET-UP B mode with the cursor to the left of group 1.
4. Advance cursor to right until it is over the third bit position of group 1. At this time the set up prompt message “screen background: light/dark” will appear on the display with a line under either the word “light” or “dark” to indicate the existing set-up condition.
5. Bit 3 of group 1 also indicates (by digit ‘0’ or ‘1’) which condition exists. This bit and the location of the underline for “light” or “dark” and the screen background will all change each time the ^6 key is pressed, (Bit 3 will be displayed as a ‘0’ or ‘1’).
6. After selecting the desired background condition, press the SET-UP key to leave SET-UP mode.

By using the above technique, it is possible to change any SET-UP bit in any SET-UP mode.

## 2.6.5 INTERFACING

**2.6.5.1 Communication Ports.** In the standard system configuration the CIT-101 is interfaced with the host computer via the communication I/O port according to EIA RS232 or 20 ma current loop conventions. See Figure 2-2 for location of the communication and printer connector. The male D connector labeled COMM, located at the rear of the CIT-101 is used for host computer communication. Table 2-1 provides the RS232-C pin assignments for the COMM connector. Communication parameters, (eg: baud rates, parity, etc.), are selected via the SET-UP modes (refer to Section III).

The CIT-101 also provides an optional bidirectional auxiliary port. This port is RS232 or current loop compatible and is designed to support a variety of peripheral devices. The female D connector, labeled PRINTER, located at the rear of the terminal, is utilized for this purpose. Table 2-2 provides the pin assignments for the PRINTER port. All parameters are set for the PRINTER port via SET-UP D mode. The D connector pin locations are shown in Figures 2-3 and 2-4.

**2.6.5.2 Current Loop Interface.** The CIT-101 offers a 20 ma current loop interface as a standard feature. The 20 ma current loop interface may only be used to handle data on one port at a time, either the communication port or the auxiliary port. No modifications are required to use the 20 ma current loop since it is implemented via normally unused pins in the two port connectors. External jumpering as illustrated in Figures 2-5 or 2-6 is used to establish the desired current loop configuration. The current loop has two jumper selectable modes of operation, either active or passive. The CIT-101 can be used as the 20 ma current source (active) or as the 20 ma current loop sink (passive). Selection of the mode requires external jumpering within the D connector. In the passive configuration, the XMTR line is optically isolated and goes to a mark condition when off. In the active mode the XMTR is not optically isolated and goes to a space condition.

**2.6.5.3 Communications Port Protocol.** The operational protocol, (for example: Data Bits, Parity, Baud Rate, etc.), may be enabled or disabled through the parameters stored in the terminal NVR memory. Through XON-XOFF protocol, the terminal is able to control bidirectional data flow.

**2.6.5.3.1 Received data protocol.** With Auto XON/XOFF enabled, the terminal will automatically monitor the condition of the receive data buffer. In the event the terminal is receiving data at a rate faster than it is able to process, (for example: assume a concurrent print mode utilized with a slow printer), data will soon begin to back up in the buffer. When the buffer is almost full, the terminal will automatically transmit an "XOFF" code, to request that the host suspend transmission of data. While host data is halted, the terminal continues to remove data from the buffer. When buffer capacity has been sufficiently reduced, the terminal will automatically issue an "XON" command to the host, requesting that data transmission be resumed. In this manner the terminal is able to monitor and control the rate of input data flow to ensure no loss of data.

**2.6.5.3.2 Transmit data protocol.** The transmit data protocol is the reverse of the description above and governs the terminal's ability to transmit data. The terminal recognizes an incoming "XOFF" command and halts data transmission until receipt of a subsequent "XON" command. In the conversational mode, the terminal will accept data from the keyboard after an "XOFF" is received until the terminal transmit buffer becomes full. At this time the terminal will sound the alarm for each subsequent keystroke to indicate that the data is being discarded.

Table 2-1. Communication D Connector Pin Assignments

Pin	Mnemonic	Function	Notes
1	PGND	Protective Ground	Chassis ground
2	EIATXD	EIA Transmit Data	Serial data from the terminal
3	EIARXD	EIA Receive Data	Serial data into the terminal
4	EIARTS	Request to Send	Always asserted if disabled (SET-UP C) Asserted if terminal has data to transmit
5	EIACTS	Clear to Send	Ignored if disabled (SET-UP C) Must be asserted externally for data transmission to proceed
6	EIADSR	Data Set Ready	Always ignored
7	GND	Signal Ground	Chassis and reference ground
8	EIACD	Carrier Detect	Always ignored
9		Current Loop Receive +	Tied to Auxiliary channel pin 9
10		Current Loop Receive -	Tied to Auxiliary channel pin 10
11	EIASPDS	Speed Select	Always asserted
12	EIASI	Speed Indicator	Always ignored
13		Receive Loop Bias	Tied to Auxiliary channel pin 13
14		Current Loop to EIA in	Tied to Auxiliary channel pin 14
15		NC	Not used
16		EIA to Current Loop in	Tied to Auxiliary channel pin 16
17		NC	Not used
18		NC	Not used
19	EIASPDS	Speed Select	Always asserted
20	EIADTR	Data Terminal Ready	Asserted except: 1. When powered off 2. While Off Line 3. For 3.5 seconds after Shift Break is sent
21		Transmit Loop Bias	Tied to Auxiliary pin 21
22		Ring Indicator	Always ignored
23	EIASPDS	Speed Select	Always asserted
24		Current Loop Transmit +	Tied to Auxiliary channel pin 24
25		Current Loop Transmit -	Tied to Auxiliary channel pin 25

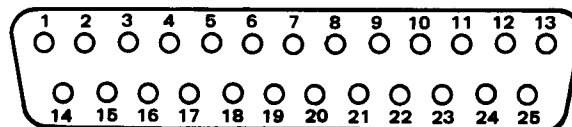

Figure 2-3. Male D Connector Pin Locations

Table 2-2. Auxiliary Port D Connector Pin Assignments

Pin	Mnemonic	Function	Notes
1	PGND	Protective Ground	Chassis ground
2	PTRXD	Receive Data	Serial data into the terminal
3	PTRTXD	Transmit Data	Serial data from the terminal
4		NC	Not used
5		NC	Not used
6		NC	Not used
7	GND	Signal Ground	Chassis and reference ground
8		NC	Not used
9		Current Loop Receive +	Tied to Communications channel pin 9
10		Current Loop Receive -	Tied to Communications channel pin 10
11		NC	Not used
12		NC	Not used
13		Receive Loop Bias	Tied to Communications channel pin 13
14		Current Loop Into EIA	Tied to Communications channel pin 14
15		NC	Not used
16		EIA to Current Loop In	Tied to Communications channel pin 16
17		NC	Not used
18		NC	Not used
19		NC	Not used
20	PTRCTS	Clear to send	Terminal will not send unless this signal is asserted
21		Transmit Loop Bias	Tied to Communications channel pin 21
22		NC	Not used
23		NC	Not used
24		Current Loop Transmit +	Tied to Communications channel pin 24
25		Current Loop Transmit -	Tied to Communications channel pin 25

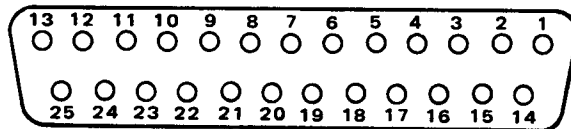

Figure 2-4. Female D Connector Pin Locations

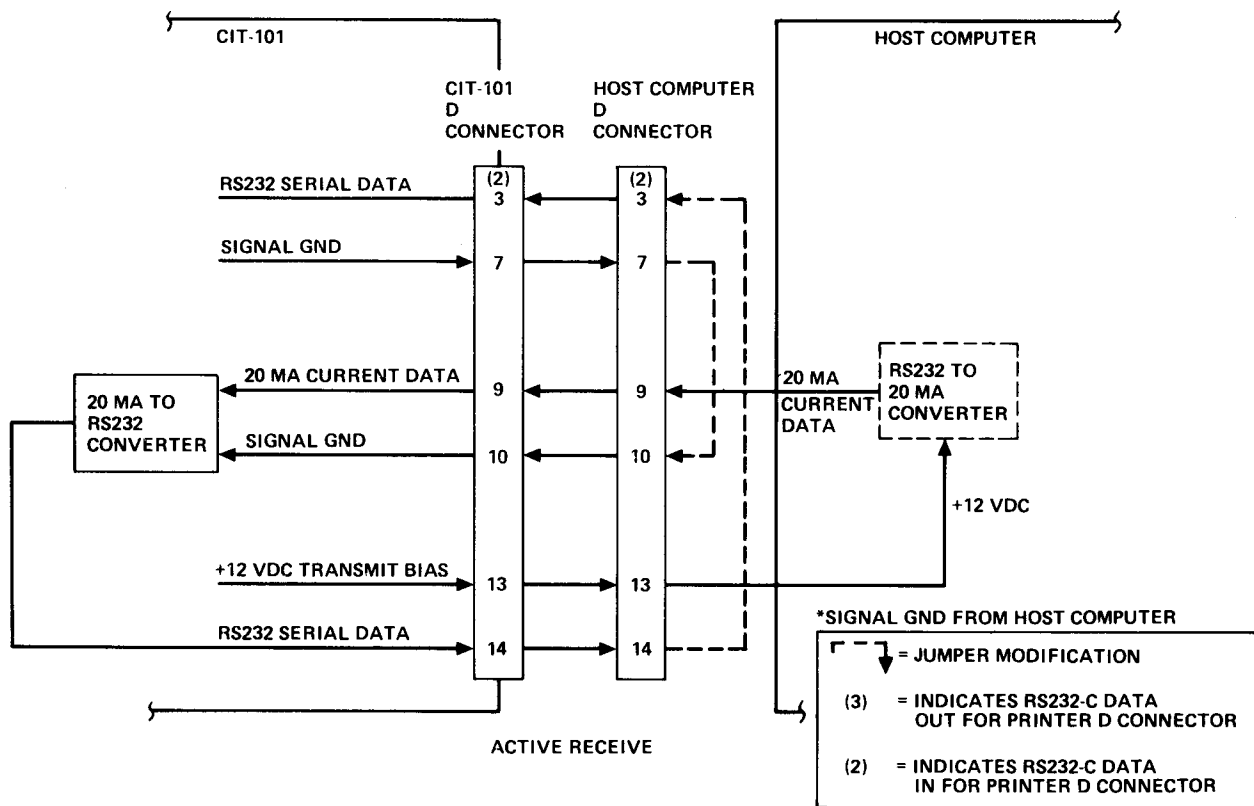
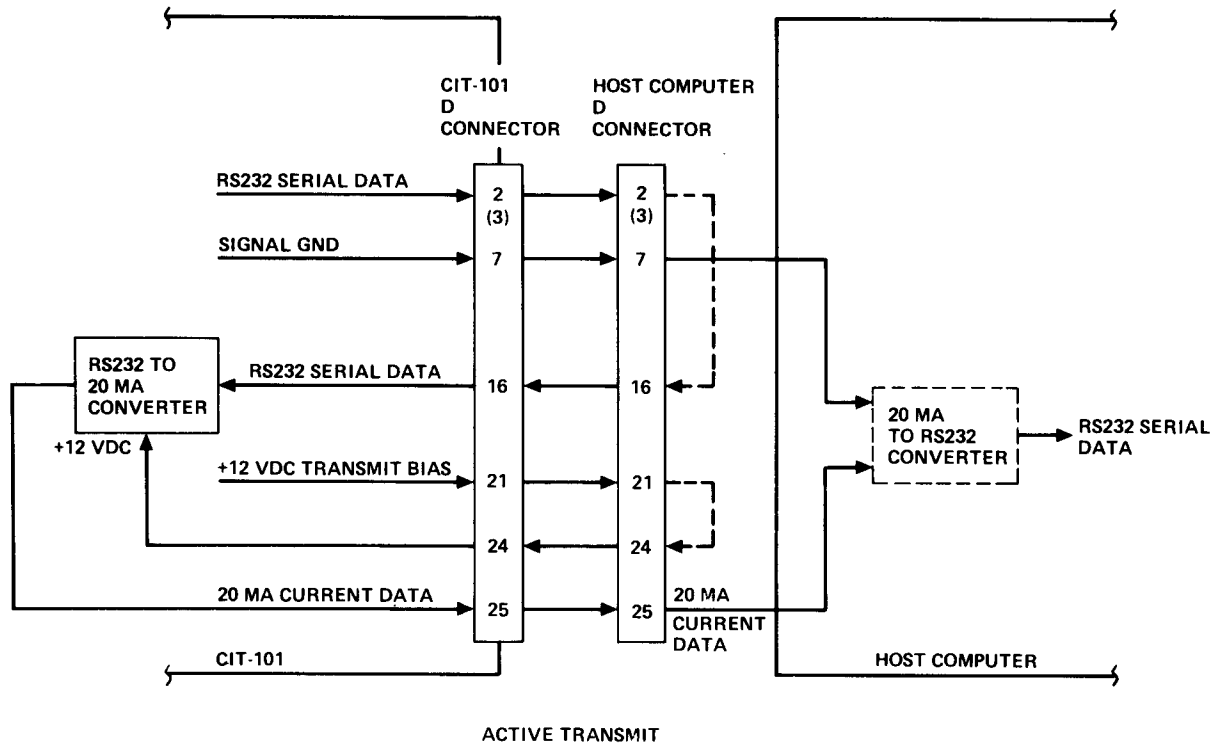

Figure 2-5. Active Configuration, 20 mA Current Loop

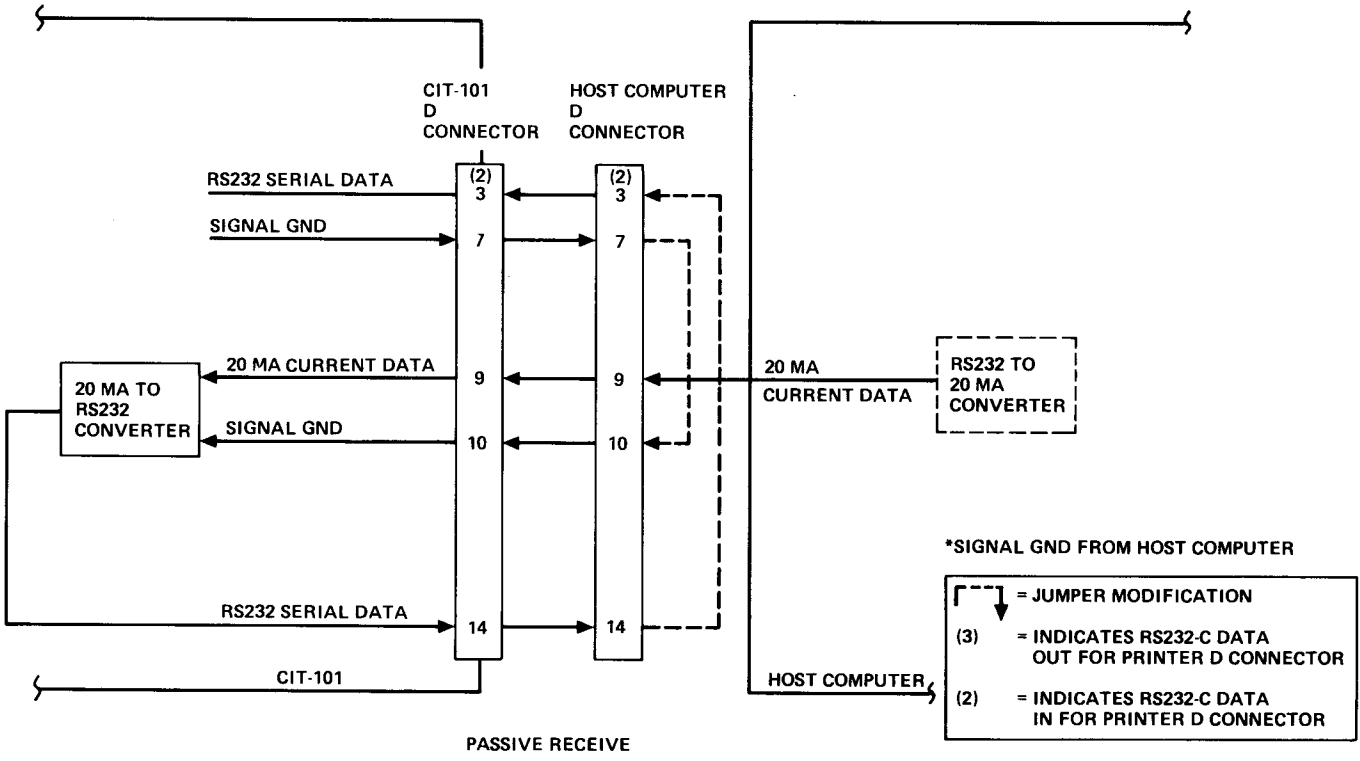
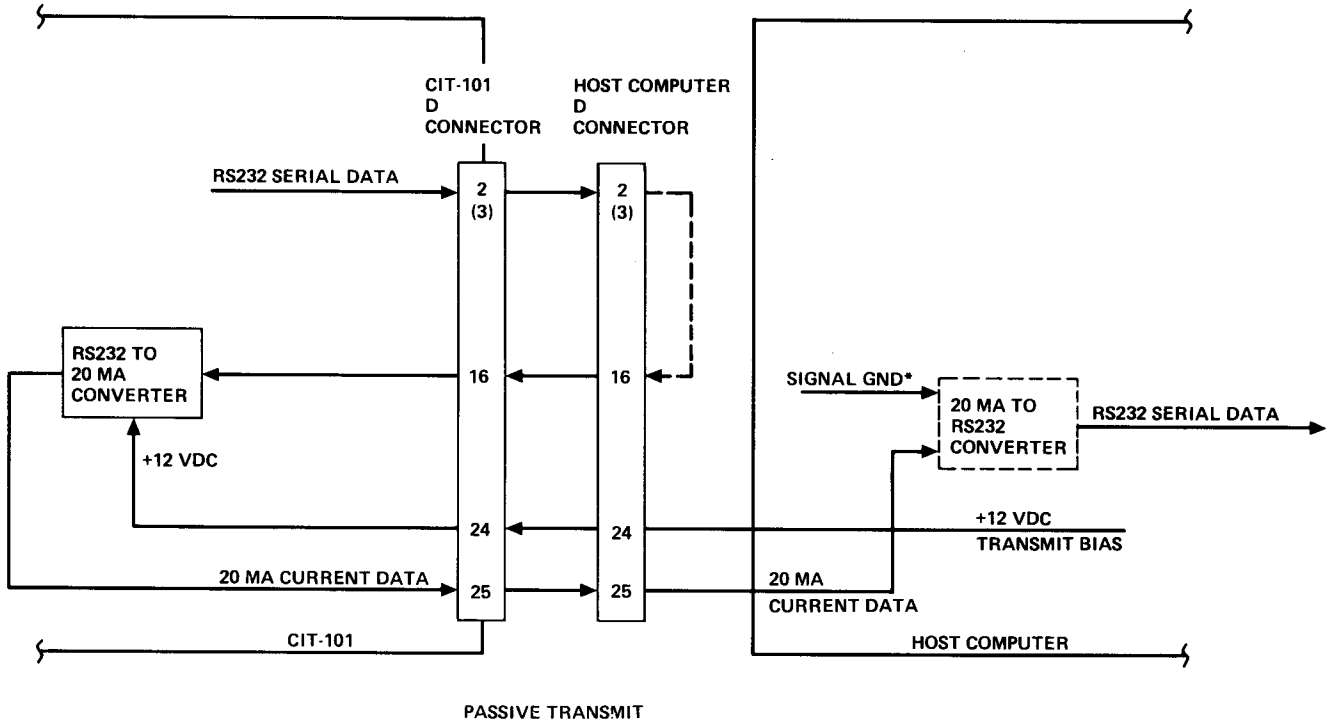

Figure 2-6. Passive Configuration, 20 mA Current Loop

**2.6.5.4 Bidirectional Auxiliary Port Protocol.** The CIT-101 Bidirectional Auxiliary Port is a powerful extension of the printer output port found on some terminals and may be used as a simple output port to drive a local printer. In this mode the terminal can accept VT52 and VT100 printer commands. Additional support for this mode is provided by a single wire READY/BUSY handshake protocol which may be used instead of, (or in addition to), the XON/XOFF handshake. For more sophisticated applications, the Bidirectional Auxiliary Port may be used for both input and output and may be interchanged with the main Communications Port in many situations. Data may be directed from the Keyboard to either the COM Port or the AUX Port, from the COM Port to either the Display or the AUX Port or both, and from the AUX Port to either the Display or the COM Port or both. To provide even greater flexibility, these paths may all be selected and controlled by either the Keyboard or the host software.

**2.6.5.4.1 Receive data protocol.** With this function enabled, the terminal controls the rate of data flow via either XON/XOFF or READY/BUSY handshake protocol. The XON/XOFF commands function exactly as described for the communications port. Note however, that the READY/BUSY signal (pin 20 of the auxiliary port connector) is internally “pulled high”, thus asserting this signal to the terminal unless it is “pulled low” via external connection.

**2.6.5.4.2 Transmitted data protocol.** With this function enabled, the terminal controls the rate of data flow via the XON/XOFF protocol, which functions as previously described for the communication port.

## **2.7 CARE AND MAINTENANCE**

With the exception of an occasional dusting or cleaning, the CIT-101 should require very little care or maintenance.

Dusting should be done with a dry, lint-free cloth, when required. If the CRT screen or the plastic case need cleaning, remove the AC power cord first to prevent any accidents. Clean the terminal with a cloth dampened with a mild detergent solution. Avoid the use of strong solvent cleaners or detergents which may damage the plastic surfaces.





## SECTION III OPERATION

### 3.1 INTRODUCTION

Section III contains operator information for the keyboard, the CIT-101 SET-UP modes, terminal self-test diagnostics and user troubleshooting procedures.

### 3.2 KEYBOARD DESCRIPTION

Functionally there are four types of keys and indicators on the keyboard, refer to figure 3-1. The basic types include:

1. Standard typewriter alphanumeric keys including symbols and keyboard function keys.
2. Terminal control and function keys.
3. A calculator type numeric keypad with special function control keys.
4. Seven LED indicators consisting of three status indicators and four special function indicators.

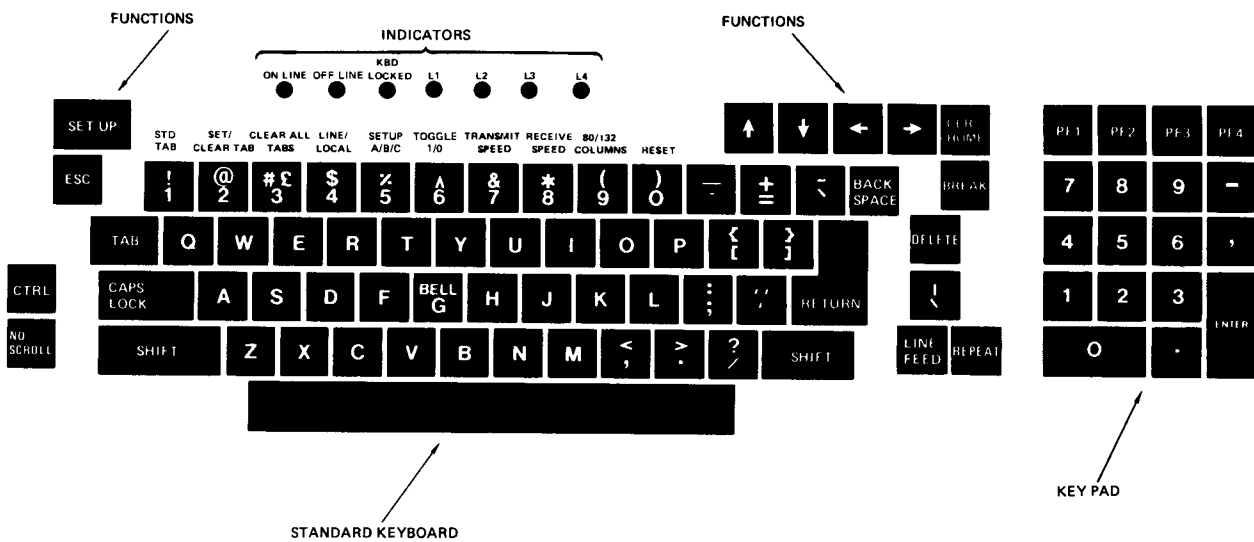

Figure 3-1. CIT-101 Keyboard

### 3.2.1 STANDARD KEYS

The standard keys of the keyboard in conjunction with the **SHIFT** and/or **CAPS LOCK** keys provide all the upper and lower case letters, numerals, and symbols found in a standard ANSI typewriter layout, refer to figure 3-2. The function keys; **BACKSPACE**, **TAB**, **RETURN**, and space bar correspond to similar key functions on a standard typewriter. The lower case letters, numerals, and symbols marked on the lower half of the key caps are produced directly by pressing the key. The upper case letters and symbols marked on the upper half of the keys are produced by depressing the **SHIFT** key and the desired key simultaneously. The **CAPS LOCK** provides the same function as the **SHIFT** key, however the **CAPS LOCK** key will lock in the down position when pressed one time, and must be pressed a second time to release. The **CAPS LOCK** key functions only with alphabetic upper case characters. Note, there are two symbols (£ and #) marked in the upper position of the 3 key, (only one is used). Refer to SET-UP B mode for selection method.

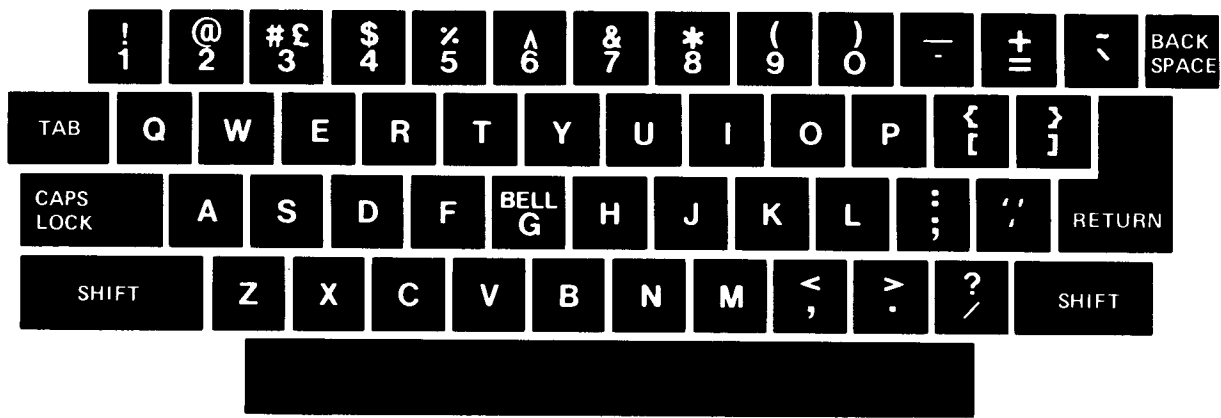

Figure 3-2. CIT-101 Standard Keyboard Keys

### 3.2.2 TERMINAL CONTROL AND FUNCTION KEYS

The keys shown in figure 3-3 are used to set up and control terminal functions. Function keys are used in conjunction with the **SHIFT** and **CTRL** keys in order to perform a terminal function. Control keys are used individually. All control and function keys generate ASCII compatible codes. Table 3-1 provides a description of the control functions available.

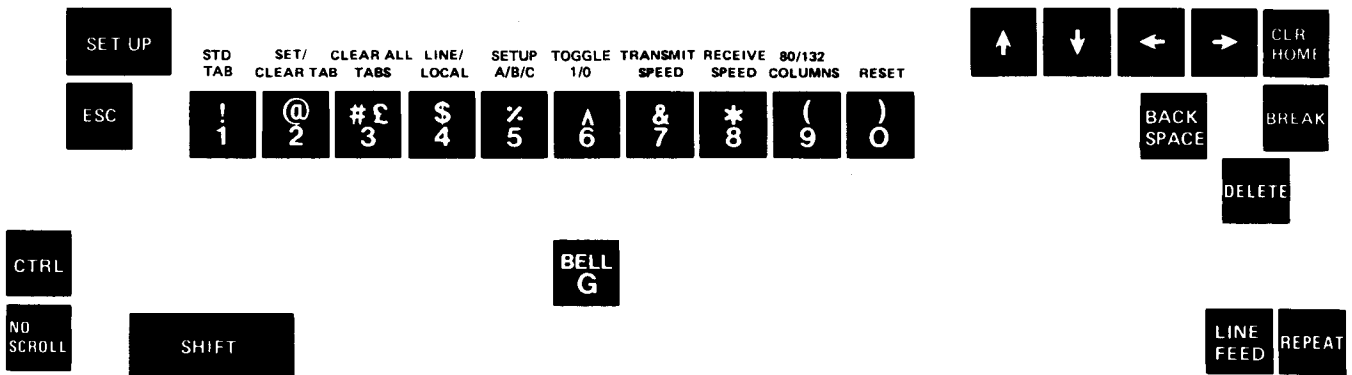

Figure 3-3. Terminal Control and Function Keys

Table 3-1. CIT-101 Terminal Control and Function Keys













Key	Description
<p>** </p>	<p>When pressed the terminal enters SET-UP A mode and halts transmission to the host computer (XOFF). When pressed a second time the terminal exits the SET-UP modes and resumes transmission to the host computer (XON).</p>
<p>** </p>	<p>In SET-UP mode, these keys increase ↑ or decrease ↓ the brightness of the display. Out of SET-UP mode, these keys move the cursor up ↑ or down ↓.</p>
<p>** </p>	<p>These keys move the cursor left ← or right → . (In or out of SET-UP mode).</p>
<p></p>	<p>When pressed, the cursor is moved to the Home position (upper left corner of screen). No programming codes are sent to peripheral equipment when this key is pressed. When pressed with the SHIFT key cursor is moved to Home position and all screen data is erased.</p>
<p></p>	<p>This key when pressed generates a code which introduces a sequence of key actions that constitute an escape command.</p>
<p>** </p>	<p>In SET-UP A mode this key when pressed places a tab stop at every eighth column.</p>
<p>** </p>	<p>In SET-UP A mode this key when pressed will cause a tab stop to be set or cleared (see SET-UP A mode).</p>
<p>** </p>	<p>In SET-UP A mode this key when pressed clears all the horizontal tabs set.</p>
<p>** </p>	<p>In the SET-UP mode, this key when pressed switches the terminal from ON LINE to LOCAL or from LOCAL to ON LINE.</p>
<p>** </p>	<p>In the SET-UP mode this key when pressed switches the terminal into the next SET-UP mode, (i.e., from A to B, from B to C, from C to A).</p>
<p>** </p>	<p>In SET-UP mode, this key is used to turn a selected feature on or off.</p>
<p>** </p>	<p>In SET-UP B mode, this key steps the transmit speed settings in the ascending order.</p>
<p>** </p>	<p>In SET-UP B mode, this key steps the receive speed settings in ascending order.</p>

Table 3-1. CIT-101 Terminal Control and Function Keys (Continued)



































Key	Description
<p>** </p>	<p>In SET-UP A mode, this key switches the display line size from 80 to 132 characters, or 132 to 80, per line.</p>
<p>** </p>	<p>In SET-UP mode this key when pressed initiates a reset sequence.</p>
<p></p>	<p>When pressed transmits a 300 msec break signal. Not active in local mode.</p>
<p></p>	<p>When pressed transmits a delete code to the host computer.</p>
<p></p>	<p>This key is used with other keys to generate special function codes.</p>
<p></p>	<p>Special function key used with CTRL to sound the Bell.</p>
<p>            (VT-100 Scroll Key Style Mode Set)</p>	<p>During data transmission, pressing this key stops the flow of data to, or from the host computer, (XOFF is generated). Pressing this key a second time restarts data transmission from the point at which it was stopped, (XON is generated). Refer to SET-UP C mode.</p>
<p> and             (VT-100 Scroll Key Style Mode Set)</p>	<p>When on-line and in VT-100 mode, these keys toggle the terminal between 'Jump Scroll' and 'Smooth Scroll' operation.</p>
<p>            (VT52 Scroll Key Style Mode Set)</p>	<p>Pressing this key simultaneously with CTRL key, (immediately after setting VT52 Scroll Key Style Mode), sets VT52 HOLD SCREEN mode, and toggles this mode ON and OFF thereafter.</p>
<p>            (VT52 Scroll Key Style Mode and HOLD SCREEN Mode Set)</p>	<p>Pressing this key causes the host computer to send a single line of data to the terminal. A key press generates XON, from terminal to host causing the host to start sending data. After receipt of a full line of data, the Terminal sends XOFF to the host. (Refer to SET-UP C mode).</p>
<p> and             (VT52 Scroll Key Style Mode and Hold Screen Mode Set)</p>	<p>Pressing these keys simultaneously causes the host to send 24 lines of data to the terminal. Pressing both keys generates XON until 24 lines of data are received. An XOFF is generated automatically after 24 data lines have been received.</p>
<p></p>	<p>This key is used with other keys to generate special function codes or upper case letters and symbols.</p>

Table 3-1. CIT-101 Terminal Control and Function Keys (Continued)

Key	Description
	When pressed generates a line feed code to the host.
	Pressing this key simultaneously with any display character key causes the terminal to display the character repeatedly. This key functions independently of the AUTO REPEAT function.
 and 	Sets beep wait mode and illuminates the keyboard locked (KBD LOCKED) indicator whereby any data typed from the keyboard is not recognized. Incoming data from the communication or auxiliary I/O channel generates a beep tone and turns off the keyboard locked indicator (operator control is regained).
 and 	Homes the cursor; clears the screen.
 and 	Sends a 3.5 second signal break. Data Terminal Ready (Pin 20 COMM connector) is placed in a deasserted state for the duration of the break. Not active in local mode.
 and 	Sends the stored answerback message to the active I/O channel.
 and 	Causes a bell code to be generated.
 and 	Save current SET-UP parameters in NVR.
 and 	Recall last-saved SET-UP parameters to NVR.
 and 	Restore factory default parameters in NVR.

\*  or  Key must be held down while indicated key is pressed.

\*\* Indicates a key which is effective in one or more SET-UP modes.

**3.2.2.1 Keyboard Cursor Control.** By using various keys, it is possible to control the location of the cursor.

The four arrow keys →, ←, ↑, ↓ move the cursor up, down, left and right respectively. Cursor movements by any of these four keys is limited to the current cursor line, for the left and right arrows and the current cursor column for the up and down functions. No scrolling or data loss can be caused by these keys.

The CLEAR/HOME key causes the cursor to move to the home location of the screen. When passed in conjunction with the shift key, the cursor will be homed and all data erased from the screen.

The BACKSPACE key moves the cursor one position to the left, until the cursor reaches the first column of the current line.

The RETURN key causes the cursor to move directly to column zero of the current cursor line. If the terminal has the 'newline mode' enabled (SET-UP B mode), the return will be converted to a carriage return-line feed sequence which will position the cursor to column zero of the next sequential line, this function will cause a destructive scroll to occur if executed on line 24.

The LINEFEED key will cause the cursor to move down one line while maintaining its current column, (on reaching line 24 destructive scrolling will be invoked). Various cursor styles (blinking, static), and shapes (block, underline, invisible), as selectable via the SET-UP modes.

Cursor control key control sequences and their utilization are identified in Section IV.

### 3.2.3 NUMERIC KEYPAD

The Numeric Keypad, (see figure 3-4), adds versatility and convenience to the CIT-101 and is made up of 18 keys grouped in a rectangle and located to the right of the Main Keypad. The Auxiliary Keypad consists of 18 keys: 0 through 9, MINUS, COMMA, decimal point (PERIOD), ENTER, and four Special Function keys designated PF1, PF2, PF3, and PF4. The Numeric Keyboard permits single key transmission of various special control sequences; direct input of decimal, and hexadecimal data; and easy control of the data flow when using the Bidirectional Auxiliary Port. Table 3-3 lists and details the various single or multiple key sequences generated by the Auxiliary Keypad in the various operating configurations described below.

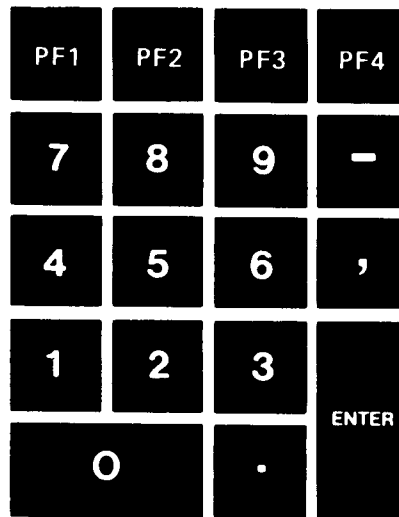

Figure 3-4. CIT-101 Numeric Keypad

**3.2.3.1 Normal Keypad Numeric Mode.** In Normal Keypad Numeric Mode operation (such as following power-up or a terminal Reset operation), the numerals and punctuation keys perform identical functions as the keys in the Main Keyboard; ENTER performs the same as RETURN (except that ENTER is not affected by Newline mode and does work with Auto Repeat), and the four Special Function Keys generate two or three character control sequences. The escape sequences generated by the Special Function Keys are often used by a Host computer to support special software functions and provide easy user input.

**3.2.3.2 Hex Keypad Numeric Mode.** With the use of SET-UP C Mode, the Numeric Keypad may be placed in Hex Keypad Numeric mode which provides the convenience of direct input of all hexadecimal characters from the Keypad. In this mode, the four Special Function Keys, MINUS, and COMMA provide the hexadecimal codes A, B, C, D, E, and F respectively as shown in Table 3-2. These are identical to the upper case letters A through F from the Main Keyboard.











**3.2.3.3 Numeric Keypad Application Modes.** In other modes of operation, the Numeric Keypad may be configured (via control sequences) to transmit either ANSI or VT52 compatible multiple key sequences in place of the normal keypad functions. These Application Mode key sequences allow special user software such as text editors to distinguish an additional 18 key codes and to assign direct commands to them for efficient user control. Table 3-2 summarizes the numeric keypad generated codes.



**Table 3-2. Numeric Keypad Generated Codes**

Key	ANSI Normal Keypad Numeric Mode	ANSI Hex Keypad Numeric Mode	ANSI Keypad Application Mode	VT52 Normal Keypad Numeric Mode	VT52 Hex Keypad Numeric Mode	VT52 Keypad Application Mode
0	0	0	<u>ESC</u> Op	0	0	<u>ESC</u> ?p
1	1	1	<u>ESC</u> Oq	1	1	<u>ESC</u> ?q
2	2	2	<u>ESC</u> Or	2	2	<u>ESC</u> ?r
3	3	3	<u>ESC</u> Os	3	3	<u>ESC</u> ?s
4	4	4	<u>ESC</u> Ot	4	4	<u>ESC</u> ?t
5	5	5	<u>ESC</u> Ou	5	5	<u>ESC</u> ?u
6	6	6	<u>ESC</u> Ov	6	6	<u>ESC</u> ?v
7	7	7	<u>ESC</u> Ow	7	7	<u>ESC</u> ?w
8	8	8	<u>ESC</u> Ox	8	8	<u>ESC</u> ?x
9	9	9	<u>ESC</u> Oy	9	9	<u>ESC</u> ?y
PF1	<u>ESC</u> OP	A	<u>ESC</u> OP	<u>ESC</u> P	A	<u>ESC</u> P
PF2	<u>ESC</u> OQ	B	<u>ESC</u> OQ	<u>ESC</u> Q	B	<u>ESC</u> Q
PF3	<u>ESC</u> OR	C	<u>ESC</u> OR	<u>ESC</u> R	C	<u>ESC</u> R
PF4	<u>ESC</u> OS	D	<u>ESC</u> OS	<u>ESC</u> S	D	<u>ESC</u> S
MINUS	MINUS	E	<u>ESC</u> Om	MINUS	E	<u>ESC</u> ?m
COMMA	COMMA	F	<u>ESC</u> OI	COMMA	F	<u>ESC</u> ?l
PERIOD	PERIOD	PERIOD	<u>ESC</u> On	PERIOD	PERIOD	<u>ESC</u> ?n
ENTER	RETURN	RETURN	<u>ESC</u> OM	RETURN	RETURN	<u>ESC</u> ?M

**3.2.3.4 Bidirectional Auxiliary Port Keyboard Control.** The Bidirectional Auxiliary Port may be controlled from the Auxiliary Keypad using the four Special Function Keys (PF1, PF2, PF3, and PF4) in combination with the Main Keyboard keys SHIFT and CTRL. The interaction and routing of data among the Keyboard, Display, Communications Port, and Auxiliary Port are all effected with these keys. The available configurations are listed and explained in Table 3-4.

Table 3-3. Auxiliary Keypad Special Functions

Special Function Keys*	Description
	<p><u>Line Send</u> – Transfers the current display line occupied by the cursor to the auxiliary I/O channel output line. This function operates in the On Line or Local mode.</p>
	<p><u>Page Send</u> – Transfers the entire contents of the display to the auxiliary I/O channel output line. If Origin Mode is set (refer to Section IV, Programming) outputs only the active portion of the display. This function operates in the On Line or Local mode.</p>
	<p><u>Keyboard to Auxiliary Mode</u> – Directs keyboard data exclusively to the auxiliary I/O channel output line and disables SHIFT PF3.</p>
	<p><u>Auto Auxiliary Mode</u> – Transfers the current display line occupied by the cursor to the auxiliary I/O channel output line whenever a linefeed is received from any I/O channel input line or the keyboard.</p>
	<p><u>Keyboard to Communication Mode</u> – Directs keyboard data exclusively to the communication I/O channel output line and disables SHIFT PF2.</p>
	<p><u>Auxiliary Control Mode</u> – Directs data received on any I/O channel input line exclusively to the auxiliary I/O channel output line (data is not displayed).</p>
	<p><u>Auxiliary Output Disable</u> – Disables all modes directing data to the auxiliary I/O channel output line, except SHIFT PF2.</p>
	<p><u>Concurrent Auxiliary Mode</u> – Directs data on any I/O input line to the display and auxiliary I/O channel output line.</p>
	<p><u>Auxiliary to Communication Mode</u> – Directs data on the input line of the auxiliary I/O channel to the output line of the communication I/O channel. This function can be performed concurrently with SHIFT CTRL PF3.</p>
	<p><u>Auxiliary to Display Mode</u> – Directs data from the input line of the auxiliary I/O channel to the display. This function can be performed concurrently with SHIFT CTRL PF2.</p>
	<p><u>Auxiliary Input Disable</u> – Disables SHIFT CTRL PF2 and SHIFT CTRL PF3.</p>

\*  and/or  key must be held down while indicated key is pressed.



### 3.2.4 INDICATORS

The CIT-101 keyboard indicators (refer to figure 3-5) provide CIT-101 status information. Table 3-4 provides a functional description of the CIT-101 indicators.

L1 thru L4 are used for user special applications. However, L1 thru L4 are also used to provide diagnostic messages. Refer to Self-Test Diagnostics in this section.

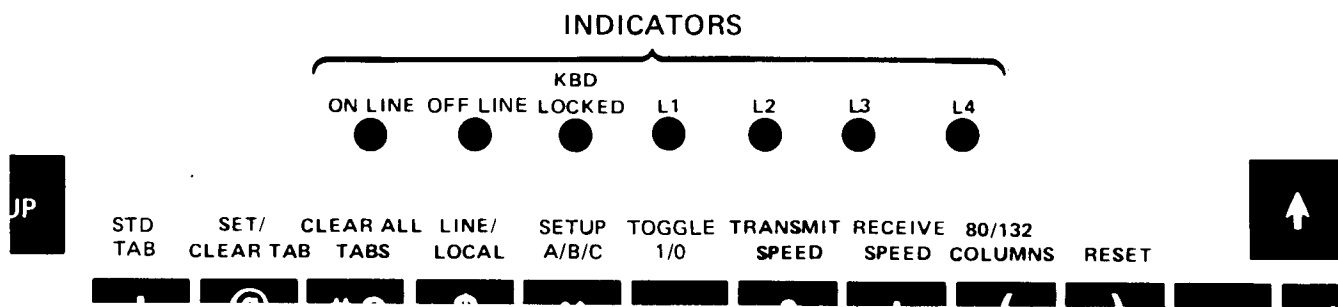

Figure 3-5. CIT-101 Keyboard Indicators

Table 3-4. Keyboard Indicator Functions

Indicator	Function
ON LINE	When on, indicates that the CIT-101 is on line and ready to communicate with the Host Computer. The ON LINE indicator blinks if the CIT-101 is set for ON LINE operation and has sent an XOFF to the host computer, temporarily suspending transmission.
OFF LINE (LOCAL)	When on, indicates that the CIT-101 is off line. Communication with the host computer is suspended.
KBD LOCKED	When on, indicates that the keyboard is locked (functionally off). Data from the host computer is still received and displayed on the screen. However, data cannot be transmitted to the host computer from the keyboard. The keyboard can be unlocked by entering and exiting the SET-UP mode.
L1 thru L4	Available for any user application. LED's are set and cleared by ANSI command codes (refer to Section IV Programming). LED's are also used for diagnostic information. Refer to diagnostic test in this section.

### **3.2.5 CIT-101 SET-UP MODES**

**3.2.5.1 Introduction.** The CIT-101 utilizes special Non-Volatile memory (NVR) to “remember” individual feature selections, settings, and parameters even after power has been removed. The user may choose to set features either temporarily (not saved after power is turned off) or permanently (until changed by the user). For convenience, there exists a factory Default set of SET-UP parameters that can easily be restored and saved using control D in SET-UP mode as shown in Table 3-4. See Section 3.2.6.5 for information on saving and recalling SET-UP mode parameters.

The CIT-101 has three SET-UP modes, called “A”, “B”, and “C”. If the Bidirectional Auxiliary Port is present and active, a fourth SET-UP mode is available and is designated “D”. All references in this manual to the Bidirectional Auxiliary Port and/or SET-UP D Mode assume that this feature is present and active and may be ignored if it is not. SET-UP A mode is entered by pressing “SET-UP”. SET-UP modes B through D are entered by repeatedly pressing the %5 key (labeled “SET-UP A/B/C” on the keyboard indicator panel). Screen Width (80 or 132 columns), Line/Local, Reset, and brightness (in thirty-two levels) may be controlled in all SET-UP modes, and any SET-UP mode may be exited by pressing “SET-UP”. SET-UP A Mode is used to locate individual TAB STOPS. SET-UP B Mode controls Communications Port baud rates, parity, and word length as well as the other standard features found in a VT100, and the VT103 compatible user flags. SET-UP C Mode controls some of the standard CIT-101 enhancements and additional VT100 compatibility features. The Bidirectional Auxiliary Port is configured in SET-UP D Mode for baud rates, parity, word length, fill characters, and selection of line terminator character.

When the CIT-101 is in any SET-UP mode, the previous contents of the Display are internally stored and XOFF, (if Auto XON-XOFF is active), is transmitted via the currently active output Port. If XOFF has been transmitted and ON LINE operation were active when SET-UP was entered, the ON LINE indicator will blink (until, and unless, a change is made to LOCAL mode) to indicate that transmission from the currently designated output port has been suspended. Each SET-UP mode display shows special information used to select and set the various special features of the terminal and only certain keys (Table 3-1) are active. Upon exiting SET-UP Mode, the original contents of the display are restored, XON is transmitted (if Auto XON-XOFF were active at the time SET-UP Mode was entered), and the ON LINE light will cease blinking, (if ON LINE operation and Auto XON-XOFF were active at the time SET-UP mode was entered).

**3.2.5.2 Common Set-up Mode Features.** Several features are common to all four available SET-UP modes. These are: Screen Width selection (80 or 132 columns), LINE/LOCAL selection, Screen Brightness, Time-of-Day Clock, and Reset of the CIT-101. These features may be used from any SET-UP mode.

**3.2.5.2.1 Screen width.** Screen width is selected from any SET-UP mode by pressing the numeral 9 key which is labelled “80/132 Columns” on the Indicator Panel. Each time this key is pressed the terminal will toggle to the other width. The current contents of the Display will be either preserved or lost depending upon the setting of the “Screen Data on 80-132 Change” bit in SET-UP C Mode. If this bit is set for “Erase”, the Display will be cleared and all data lost when the Screen Width is changed. If this bit is set to “Preserve”, no data will be lost when Screen Width is changed .

**3.2.5.2.2 Local vs on line operation.** LOCAL (OFF LINE) versus ON LINE Operation is selected from any SET-UP mode by pressing the numeral 4 key which is labelled "LINE/LOCAL" on the Indicator Panel. Each time this key is pressed in SET-UP mode, the current mode is toggled to the other and the new status is indicated by either a lit "ON LINE" or "OFF LINE" (LOCAL) light on the Indicator Panel. In LOCAL mode, keyboard data is channelled directly to the display, no interaction with the Communications Port occurs, and signal DTR is unasserted. In ON LINE mode, Keyboard data is transmitted to the Communications Port (and possibly to the Display or Auxiliary Port, depending upon user choice of Full or Half Duplex and status of the Auxiliary Port). ON LINE mode must be selected to communicate with a Host computer. LOCAL mode is used for test and familiarization purposes.

**3.2.5.2.3 Screen brightness.** The brightness of the Display may be set from the Keyboard in any SET-UP mode through the use of the vertical cursor motion keys (UP ARROW and DOWN ARROW). Pressing UP ARROW will increase brightness and DOWN ARROW will decrease it. Brightness is also controlled by the CRT Saver if enabled via SET-UP C Mode. If the CRT Saver is engaged, the Display intensity will slowly diminish to zero in 60 minutes as long as no data is input from the Keyboard, Communications Port, or Auxiliary Port. Normal Screen Brightness (as established by SET-UP mode) will be immediately restored when any character is received or typed (unless the Keyboard has been locked by the user or repeating Self-Test Diagnostics are in progress).

**3.2.5.2.4 Time-of-day clock.** A Double-Height, Double-Width, 24 hour Time-of-Day Clock is available for viewing while in any SET-UP mode. This clock is enabled and set via the same command and may be disabled if desired. Figure 3-6 shows the time of day clock display. See Section 4.4.30 for these commands.

**3.2.5.2.5 Resetting the terminal.** The CIT-101 may be reinitialized to its power-up state by entering any SET-UP mode and pressing the numeral 0 key which is labelled "Reset" on the Indicator Panel. This operation will: (1) exit SET-UP Mode, (2) run the basic Self-Test Diagnostics (causing the Display to be busy for several seconds while the tests run), (3) clear the Display, (4) perform a Recall operation to restore the parameters currently saved in NVR (replacing any temporarily set parameters), and reset all modes that may have been set by the user (such as character set selection, Keypad Application mode, etc.).

**3.2.5.3 Setting/Resetting Set-up Mode Bits.** SET-UP Modes B, and C, (and D if applicable) each show several groups of up to four bits (1's and 0's) each, that are referenced by Group numbers beginning with the left-most group. Individual bits may be toggled by placing the cursor over the desired bit using the LEFT ARROW, RIGHT ARROW, TAB, BACKSPACE, RETURN or SPACE keys and pressing the numeral 6 key (labelled Toggle I/O on the Indicator Panel). The purpose of each bit is shown by individual messages that are displayed as the cursor is positioned over each bit. The currently active status of the selected bit is also reflected by the underlined portion of the text in the message. (Note that if Cursor Invisible mode is set, only the messages will appear, without a displayed cursor.)

### 3.2.6 CIT-101 SET-UP MODE OPERATION

The explanation of the display, and uses of SET-UP modes A through D follows.

**3.2.6.1 SET-UP A Mode.** SET-UP A Mode is entered by pressing the “SET-UP” key. In this mode the Display shows in ruler fashion the locations of all the currently set TAB STOP positions and the currently selected Screen Width. Each available column is numbered in repeating groups of 1 through 0 for easy location of the TAB STOPS. Figure 3-6 shows a picture of SET-UP A Mode.

#### NOTE

The “ruler” contains either 80 or 132 spaces dependent on line length selection.

Tabs are automatically set at every eighth column (standard tabs) by pressing the 1 key (STD TAB). The tab stops are individually set or reset utilizing the tab set/clear key. Position the cursor using the ← and → keys over the tab position desired and press the 2 key. All tabs can be cleared by pressing the 3 key. The SET-UP A mode is exited by pressing the SET-UP key.

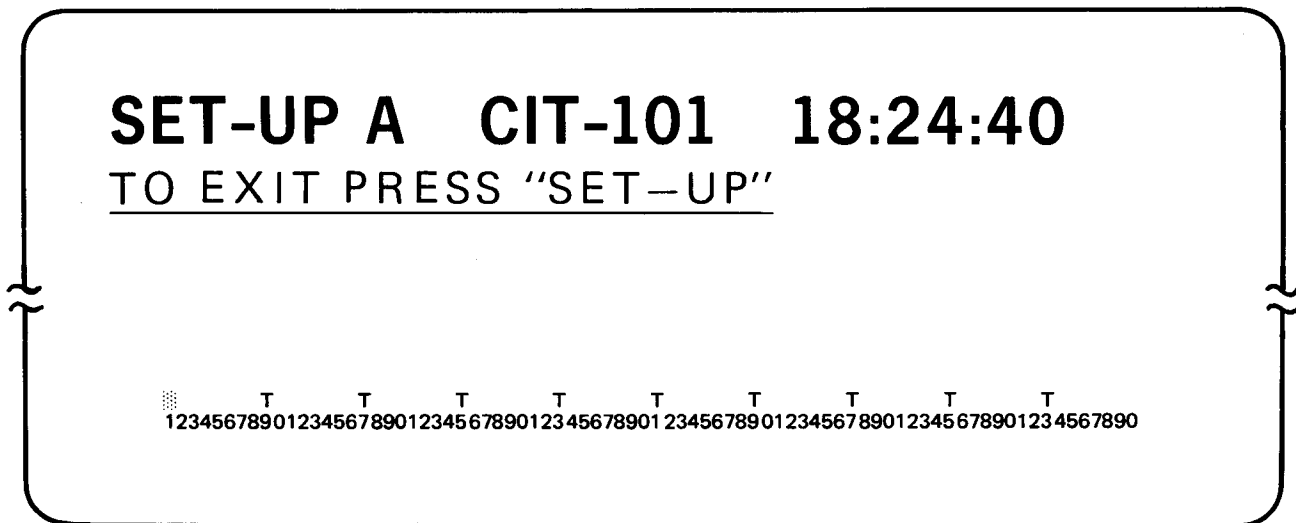

Figure 3-6. SET-UP A Mode With Time-of-Day Clock Display

**3.2.6.2 SET-UP B Mode.** The SET-UP B mode is entered from the SET-UP A mode by pressing the 5 key (SET-UP A/B/C mode). To exit the SET-UP B mode press the SET-UP key.

When the SET-UP B mode is entered, the bottom line of the display summarizes the SET-UP B mode control conditions. Individual control conditions (refer to figure 3-7) are represented by a 1 or 0. In the SET-UP B mode there are five groups of control conditions (labeled 1, 2, 3, 4, 5). There are four control conditions in each group. Moving the cursor over a control condition causes the description and options for that particular control condition to be displayed. The active control condition option is underlined. Control conditions are changed by positioning the cursor over a control condition and pressing the 6 key (Toggle 1/0). Table 3-5 presents the group position, the displayed description, 1/0 options and default values of SET-UP B mode control conditions. Table 3-6 presents a description of SET-UP B mode control condition options.

To change the transmit speed, press the 7 key. Pressing this key once advances the display to the next higher speed. Repeat until desired speed is displayed. To change receive speed, press the 8 key the transmission speed steps to next higher baud rate. Repeat until the desired speed is displayed.

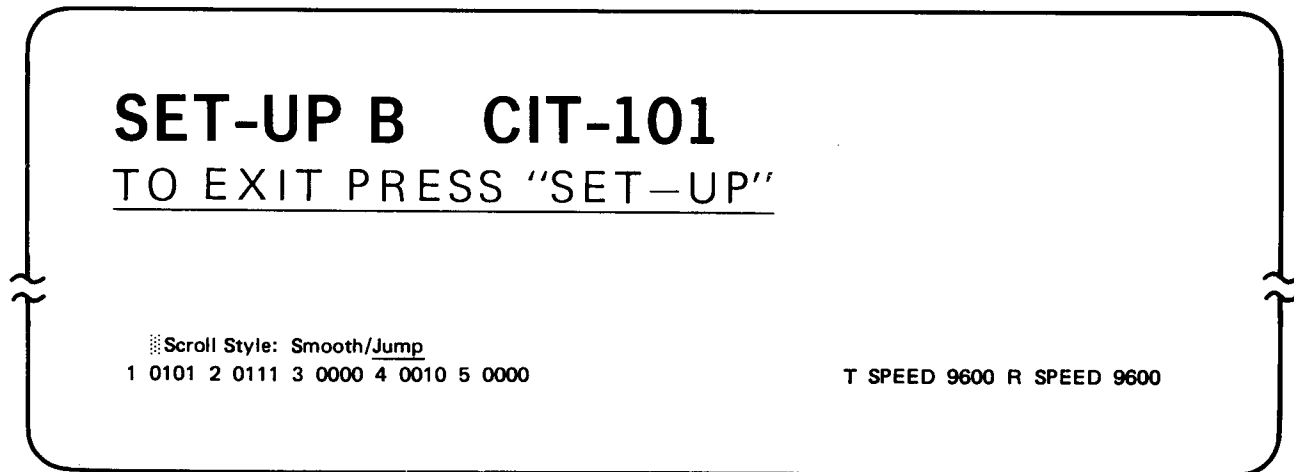

Figure 3-7. SET-UP B Mode Display

Table 3-5. SET-UP B Mode Control Conditions

Group	Displayed Description:	1/0	Default Value
Group 1 Position			
1	Scroll Style:	Smooth/Jump	Jump
2	Auto Repeat:	On/Off	On
3	Screen Background	Light/Dark	Dark
4	Cursor:	Block/Underlined	Block

Table 3-5. SET-UP B Mode Control Conditions (Continued)

Group	Displayed Description:	1/0	Default Value
<b>Group 2 Position</b>			
1	Margin Bell:	On/Off	Off
2	Keyclicks:	Audible/Silent	Audible
3	<input type="checkbox"/> (Cursor)	ANSI/VT52	ANSI
4	Auto XON-XOFF:	On/Off	On
<b>Group 3 Position</b>			
1	Shift # or £:	£/#	#
2	Auto wraparound:	On/Off	Off
3	New line:	On/Off	Off
4	Interlace	Off	Off
<b>Group 4 Position</b>			
1	Parity:	Even/Odd	Odd
2	Parity:	Enable/Disable	Disable
3	Bits per character:	8/7	8
4	Screen frequency:	50/60 Hz	60 Hz
<b>Group 5 Position</b>			
1	Flags	8/0	0
2	Flags	4/0	0
3	Flags	2/0	0
4	Flags	1/0	0

**Table 3-6. SET-UP B Mode Control Condition Options**

Control Condition Option	Description
Scroll Style Jump	After screen is full, each new line to be displayed is added as a complete character line at a time, giving the effect of "Jump Scroll".
Scroll Style Smooth	After screen is full, each new line to be displayed is added as a dot line at a time, giving the effect of smooth scroll, use with AUTO XON/XOFF.
Auto Repeat	When ON, if a key is held down for 0.5 sec or longer the character of that key is repeated until key is released
Screen Background	Screen background can be either dark (normal) or light (reversed).
Cursor	The cursor may be a block (normal) or a underline.
Margin bell	When ON, a beep tone occurs when the cursor is eight columns away from the end of the display. When ON, this control condition is active in any screen width display mode.
Keyclicks	When ON, an audible keyclick is generated when a key is pressed.
ANSI Mode	When selected, American National Standards Institute programming control sequences are used (refer to Section IV).
VT52 mode	When selected Digital Equipment Corporation (DEC) VT52 control sequences are used (refer to Section IV).
Auto XON/XOFF	When ON, on line transmission to the CIT-101 is controlled by the CIT-101. When data cannot be displayed as quickly as it is received the CIT-101 generates an XOFF. The XOFF inhibits transmissions from the host computer. The CIT-101 generates an XON when received data can be displayed. The XON allows the host computer to resume transmission. XON/XOFF does not function when the CIT-101 is in the LOCAL (OFFLINE) mode.
Select # or £	Allows the user to select the ASCII character # (normal), or, the British standard character £.
Auto Wraparound	When ON, causes an automatic return and linefeed. When the cursor is at the end of the display line the CIT-101 will automatically begin displaying data in column 1 of the next line down.

Table 3-6. SET-UP B Mode Control Condition Options (Continued)

Control Condition Option	Description
New line	When ON, Pressing the <b>RETURN</b> key automatically generates a carriage return and linefeed. A carriage return from the host computer is automatically interpreted as a carriage return and linefeed. If the host computer automatically sends carriage return and linefeed codes then New line should be OFF.
Interlace	Always off
Parity Odd/Even	Even or odd parity is detected dependent on host computer communication configuration. Used only when Parity is enabled.
Parity Enable	When enabled parity is set during transmission and checked during reception. Used in accordance with host computer communication configuration. Error characters are displayed when parity error is detected.
Bits per character	The user may select 7-or 8-bit data words for serial transmission. Selection of word length is dependent on host computer communication configuration.
Screen Frequency	The user selects 50 or 60 Hz screen frequency. Screen Frequency must be compatible with AC line voltage frequency.
Flags	All Flags summed together to provide a 0-15 decimal value (refer to "Reports" Section IV).

**3.2.6.3 SET-UP C Mode.** The SET-UP C mode can only be entered from the SET-UP B mode. To enter the SET-UP C mode press the 5 key (SET-UP A/B/C). To exit the SET-UP C mode press the SET-UP key.

When the SET-UP C mode is entered the bottom line of the display summarizes the SET-UP C mode control conditions (refer to figure 3-7). Individual control conditions are represented by a 1 or 0. In the SET-UP C mode there are five groups of control conditions (labeled 1, 2, 3, 4, 5). Moving the cursor over a control condition causes a description, and options, for that particular control condition to be displayed. The active control condition option is underlined. Control conditions are changed in the same manner as in the SET-UP B mode. Table 3-7 presents the group location, displayed description and default values of SET-UP C mode control conditions. Table 3-8 presents a functional description of the SET-UP C mode control condition options.



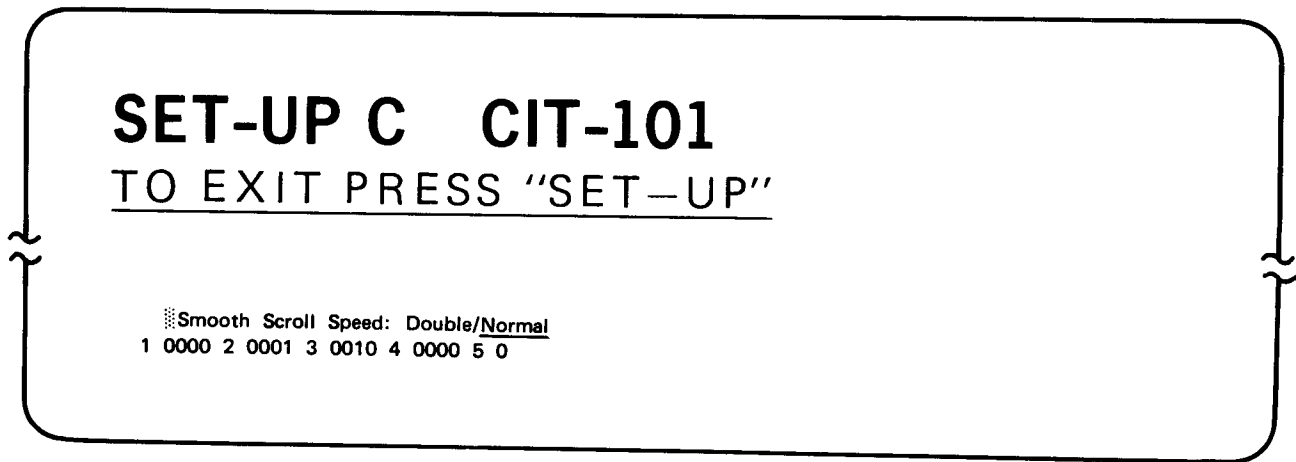

Figure 3-8. SET-UP C Mode Display

Table 3-7. SET-UP C Mode Control Conditions

Group	Displayed Description	1/0	Default Value
Group 1 Position			
1	Smooth Scroll Speed:	Double/Normal	Normal
2	Scroll Key Style:	VT52/VT100	VT100
3	Aux Numeric Keypad:	Hex/Normal	Normal
4	Form-Feed:	Home & Clear/Line-Feed	Line-Feed
Group 2 Position			
1	Control Characters:	Visible/Executed	Executed
2	Incoming XOFF (^S):	Disable/Enable	Enable
3	Cursor:	Invisible/Visible	Visible
4	Cursor:	Blinking/Constant	Blinking
Group 3 Position			
1	Screen Data on 80-132 change:	Erase/Preserve	Preserve
2	RH of DW lines:	Erase/Preserve	Preserve
3	Erase Page Extent:	Within margins/Full page	Within margins
4	Tab Motion:	Spaces/Direct	Direct

**Table 3-7. SET-UP C Mode Control Conditions (Continued)**

Group	Displayed Description	1/0	Default Value
Group 4 Position			
1	CRT saver	ON/OFF	OFF
2	<input type="checkbox"/> (Cursor)	Half Duplex (local echo)/ Full Duplex	Full Duplex
3	RTS-CTS Handshake:	Disable/Enable	Enable
4	8th Bit on Transmit:	Mark/Space	Space
Group 5 Position			
1	STOP Bits on transmit:	2/1	1

**Table 3-8. SET-UP C Mode Control Condition Options**

Control Condition Options	Description
Smooth Scroll Speed	The scrolling rate of text on the display screen is determined by selecting Normal or Double Smooth Scroll speeds. This control condition is used only when Smooth Scroll is enabled.
Scroll Key Style VT52	When this mode is selected the NO SCROLL key controls data transfer and display. The NO SCROLL key in VT52 key style scroll mode adds one line of display data to the display. When pressed simultaneously NO SCROLL and SHIFT fill the display area with text (a total of 24 lines). The VT52 scroll key style mode is only operable when Hold Screen mode is set. The Hold Screen mode is set by pressing CTRL and NO SCROLL, or by sending the appropriate command sequence from the host computer (refer to Section IV, Programming).
Scroll Key Style VT100	When this mode is selected the NO SCROLL key controls data transfer and display. In this mode display data scrolling on the screen is halted (XOFF) when the NO SCROLL key is pressed. Display data resumes (XON) scrolling when the NO SCROLL key is pressed a second time.
AUX Keypad Hex	When the Hex mode is selected the numeric keypad is placed in the hexadecimal Keypad mode (refer to table 3-2).
AUX Keypad Normal	When the normal mode is selected the keys on the numeric keypad correspond to the engraved character.
Form-Feed Home & Clear	When Home & Clear is selected an incoming Form Feed character homes the cursor and clears the display.

**Table 3-8. SET-UP C Mode Control Condition Options (Continued)**

Control Condition Options	Description
Form-Feed Line-Feed	When Line-Feed is selected an incoming Form Feed character causes a single line feed to occur.
Control Characters Visible	In either ANSI or VT52 mode control sequences are displayed but not executed. The LINE FEED key causes a CARRIAGE RETURN and LINE FEED to occur. LINE FEED is the only control sequence executed in the Control Character Visible Mode. Auto wraparound is automatically set (refer to SET-UP B mode). Control characters are displayed in reverse video.
Control Character executed	In either ANSI or VT52 mode control sequences are executed (but not displayed).
Incoming XOFF ( S)	When disabled, the CIT-101 continues transmitting data to the host computer (prevents keyboard lockout). An XOFF sent by the host computer is ignored by the CIT-101.
Cursor Visible	Cursor visible or invisible may be selected.
Cursor Blinking	Cursor Blinking or constant may be selected.
Screen Data on 80-132 Change – Erase	When Screen width is changed from 132 to 80 the display is erased and the cursor is sent to the home position.
Screen Data on 80-132 Change – Preserve	When the Screen Width is changed from 132 to 80 the display is preserved. The cursor and complete display text remain visible on the screen.
Right Half (RH) of Double Width (DW) Lines Erase	When a line is converted to double width the original right half portion of the line is erased. If the line is converted back to single width the original right hand portion of the line is not displayed.
Right Half (RH) of Double Width (DW) Lines Preserve	When a line is converted to double width the original right half portion of the line is preserved, but not displayed. If the line is converted back to single width the right hand portion of the original line is displayed.
Erase Page Extent Within Margins	When in this mode, erase page commands erase data within the margins of the display area. However, the CLR HOME key must be defined by origin mode (refer to cursor control, Section IV).
Erase Page Extent Full Display	When in this mode erase page commands erase the entire display area.
Tab Motion Spaces	Any character passed over by the cursor as the cursor moves to the next tab position will be changed to a space.

**Table 3-8. SET-UP C Mode Control Condition Options (Continued)**

Control Condition Options	Description
Tab Motion Direct	If a character is passed over while the cursor is moving to the next tab position, that character is not affected.
CRT Saver	When on, the screen brightness diminishes over approximately a 60 minute period of inactivity. The brightness returns to normal when 1) data is received or 2) a key is pressed.
Half Duplex (local Echo)	All keyboard transmissions are sent to the display as well as the host computer.
Full Duplex	All keyboard transmissions are sent to the host computer. The host computer then sends (Echoes) the data back to the CIT-101 for display.
RTS-CTS Handshake	When RTS-CTS is disabled, the user can interface to devices that do not conform to EIA communication standards.

**3.2.6.4 SET-UP D Mode.** The SET-UP D mode is only available if the optional Bidirectional Auxiliary Port is installed.

The SET-UP D mode can only be entered from the SET-UP C mode. To enter the SET-UP D mode press the 5 key (SET-UP A/B/C). To exit the SET-UP D mode press the SET-UP key. When the SET-UP D mode is entered, the bottom line of the display summarizes the SET-UP D mode control conditions (refer to figure 3-9). Individual control conditions are represented by a 1 or 0. In the SET-UP D mode there are three groups of control conditions (labeled 1, 2, 3). Moving the cursor over a control condition causes a description and options for that particular control condition to be displayed. Control conditions are changed in the same manner as the SET-UP B mode. Table 3-9 presents the Group location, displayed description and default values of SET-UP D mode control conditions. Table 3-10 presents a functional description of the SET-UP D mode control condition options.

The SET-UP D mode allows the user to select a specific quantity of fill characters (refer to appendix B). Fill characters are produced each time a line terminator character is encountered. To select a quantity of fill characters press the + key (to increase) or - key (to decrease). Baud rates in the SET-UP D mode are changed in the same manner as in the SET-UP B mode.

# SET-UP D CIT-101

## TO EXIT PRESS "SET-UP"

Parity: Even/Odd  
 1 0010 2 1010 3 001

FILL=0 P T SPD 9600 P R SPD 9600

Figure 3-9. SET-UP D Mode

Table 3-9. SET-UP D Mode Control Conditions

Group	Displayed Description	1/0	Default Value
<b>Group 1 Position</b>			
1	Parity:	Even/Odd	Odd
2	Parity:	Enable/Disable	Disable
3	Bits per character:	8/7	8
4	Incoming XOFF (^S):	Disable/Enable	Enable
<b>Group 2 Position</b>			
1	Fill After:	CR/LF	CR
2	Non Fill Character:	Supress/Transmit	Transmit
3	Auto XON-XOFF:	ON/OFF	ON
4	8th Bit on TX:	Mark/Space	Space
<b>Group 3 Position</b>			
1	Stop Bits on TX:	2/1	1
2	Output Page Termination:	Form Feed/None	None
3	Output Page Extent:	Full Screen/Within Margins	Full Screen

**Table 3-10. SET-UP D Mode Control Condition Options**

Control Condition Options	Description
Parity Sense	User's selected odd or even parity communication capability with auxiliary I/O channel device.
Parity Enable	When enabled, parity is set during transmission and checked during reception.
Bits per character	User selected 7- or 8-bits for serial transmission word length.
Incoming XOFF(^S)	Allows the device on the auxiliary I/O channel to halt the CIT-101 transmission. Any data transmitted by the CIT-101 to the auxiliary channel device can be halted by the device when this option is enabled.
Fill After CR/LF	The CIT-101 allows the user to select either CARRIAGE RETURN or LINE FEED as the character to be followed by an optional number of fill characters. This allows flexibility in using peripheral devices such as printers that require fill characters and/or use line terminators other than the customary CARRIAGE RETURN followed by LINE FEED. This feature may be disabled by setting the Fill Character Count to 0.
Non-Fill Character	The user may choose to suppress or transmit the character that was chosen as the fill after character in the Fill After CR/LF control condition description.
Auto XON-XOFF	With Auto XON-XOFF enabled, the CIT-101 transmits ASCII character XOFF (CONTROL S) to the device attached to the Auxiliary I/O channel whenever the CIT-101 input buffer is nearly full. The attached device must respond by halting transmission of additional characters. When the input buffer of the terminal is nearly empty, the terminal transmits an XON (CONTROL Q) which should cause that device to resume data transmission.
8th Bit on Transmit Mark	When odd parity is enabled the 8th bit on transmit is set to a Mark.
8th Bit on Transmit Space	When even parity is enabled the 8th bit on transmit is set to a Space.
STOP Bits on Transmit.	STOP bits on transmit are to be selected in compliance with user's host system communication parameters.
Output Page Termination	In a Page Send operation (refer to Numeric Keypad Special Functions) this option allows the user to select a Form Feed code as the final character of a page of text.

Table 3-10. SET-UP D Mode Control Condition Options (Continued)

Control Condition Options	Description
Output Page Extent Full Screen	In a Page Send operation this option transfers the entire screen area without reference to margins.
Output Page Extent Within Margins	In a Page Send operation this option transfers only the screen area within margins.

**3.2.6.5 SET-UP Mode SAVE and RECALL Operations.** Any changes made in any SET-UP mode are temporary until permanently stored in memory with a SAVE operation. Temporary changes are lost if power is removed, the terminal is reset, a RECALL operation is performed, or factory Default Conditions are restored.

**3.2.6.5.1 SET-UP mode save operation.** Control conditions are stored in Non-Volatile Ram Memory (NVR) on a permanent basis by entering any SET-UP mode and pressing CTRL and S. The terminal automatically enters SET-UP B mode, illuminates the KBD LOCKED indicator, and displays the word WAIT on the lower left corner of the screen. When all the new data has been successfully transferred to the NVR the word DONE appears, a keyclick occurs and the keyboard is unlocked. With the new SET-UP parameters now stored in NVR the operator may exit SET-UP. *DO NOT TURN OFF THE POWER WHILE A SAVE OPERATION IS IN PROGRESS WITH THE WAIT MESSAGE DISPLAYED!*

**3.2.6.5.2 SET-UP mode recall operation.** The user stored permanent SET-UP conditions are automatically restored whenever the terminal is turned on or reset. In addition, a special RECALL operation may be performed to reinstate permanently stored control conditions by entering any SET-UP mode and pressing CTRL simultaneously with R. The word WAIT is momentarily displayed while the control conditions are again recalled. The operation is completed when a keyclick occurs and the word DONE appears. The terminal is now operating with the user selected permanent SET-UP control conditions.

**3.2.6.5.3 SET-UP mode restored to factory default condition.** The factory established Default Conditions may be restored by entering any SET-UP mode and pressing CTRL simultaneously with D. The word WAIT is momentarily displayed while the Default SET-UP conditions are loaded into the NVR. The operation is complete when a keyclick occurs and the word "DONE" appears on the screen. The terminal is now operating with the factory Default Permanent SET-UP control condition.

### **3.2.7 ANSWERBACK MESSAGE**

The answerback feature allows the CIT-101 terminal to identify itself to the host. The answerback message is entered by the operator during SET-UP and is sent to the host either automatically when the host requests identity or by pressing the **CTRL** and **BREAK** keys simultaneously. To set the answerback message:

1. Place CIT-101 in SET-UP B mode.
2. Press **CTRL** and **A** keys simultaneously.
3. Verify that **A =** appears on the screen.
4. Type delimiter character.

#### **NOTE**

Delimiter can be any character not used as actual part of answerback message.

5. Type the answerback message which can be up to 20 characters long, including spaces and control characters.

#### **NOTE**

Control characters are displayed in reverse video in their ASCII format. The host computer solicits a stored answerback message (if present) by using an ASCII ENQ code (refer to Section IV, Programming).

6. Type delimiter character. Message now disappears from screen.

#### **NOTE**

If an error is made in entering message, type delimiter and go back to step 2.

Once entered the answerback message is temporarily stored. A **SAVE** operation must be performed to permanently store the message.



### 3.2.8 SELF-TEST DIAGNOSTICS

The CIT-101 contains self-test diagnostic firmware which may be used to verify terminal operation and to assist in isolating malfunctions. The basic self-test is automatically performed whenever the terminal is turned on or reset. Diagnostic tests may be initiated either by the operator or the Host Computer.

Specific self tests are initiated by receiving the ANSI-only control sequence

ESC[2;P<sub>s</sub>

where "P<sub>s</sub>" is a parameter chosen for the desired test(s) as follows:

<u>Function Tested</u>	<u>Parameter (P<sub>s</sub>)</u>
Same as power up	1
ROM	
NVR	
RAM	
Dual Channel loop back; COMM Channel to Aux Channel	2*
EIA loop back	4**
Continuous testing of selected functions	8

\*Requires Dual Port Loop Back Connector

\*\*Requires EIA Loop Back Connector

To perform more than one selected test continuously until a failure is detected, use a parameter equal to the sum of those parameters given for the tests desired. For example, to run the EIA loop back and power up tests continuously, use a parameter of  $(1+4+8) = 13$ . When a continuous test is in progress, user control can only be acquired by turning the power off and on. It is not possible to run the dual channel loop back test and EIA loop back tests concurrently.

**3.2.8.1 Error Messages.** The diagnostics indicate detected errors to the user in the form of an on-screen message in the upper left corner of the display. At the same time, a binary code, corresponding to the sum total of errors detected, is displayed at the four user programmable indicators (L1 through L4). Each test ends with a "TEST DONE" message followed by an error message for each error condition detected or the message "NO ERRORS DETECTED," indicating successful completion of Test(s) run.

### 3.2.8.1.2 Power on/reset error messages.

#### 'CHECKSUM ERROR ON NVR' [parameter]

Indicates a fault in the Non-Volatile RAM (NVR) circuitry detected by comparing the checksum stored in NVR at the time of the last SAVE operation with the checksum computed by the diagnostic. May mean that one or more SET-UP bits or features may be altered or unstable. The parameter given is two ASCII characters representing two 4-bit parts of the 8-bit checksum computed, where each part has been added to hex 40 for the purposes of display (for example, @@ is 00, @A is 01, etc.). Perform a SAVE operation to clear.

#### 'CHECKSUM ERROR ON ROM' [parameter]

Reports an error that occurred when the checksum stored for each program ROM (or PROM) in the main program memory was compared against the checksum computed by the diagnostic. The parameter will be one of the numerals 0 through 3 which corresponds to the location of the faulty memory device (device 0 is at address hex 0000, etc.). This message will be repeated with a different parameter for each faulty device encountered.

#### 'RAM READ/WRITE ERROR' [parameter]

Indicates that an error was detected during various read and write operations performed throughout the two 16K RAM banks in the unit. The error parameter is displayed as four ASCII characters. The ASCII code for each of the displayed characters is the sum of a hexadecimal 40 and an 8-bit fault code (refer to CIT-101 Maintenance Manual).

**3.2.8.1.3 Dual loop back test error messages.** The following messages can occur only if the dual channel loop back test is executed. The Dual Channel Loop Back Connector must be installed between the COMM Channel connector and Auxiliary Channel connector for these tests to run successfully.

#### 'COMM UART NOT READY TO TRANSMIT'

The Universal Asynchronous Receiver Transmitter (UART) for the Communications channel transmit ready signal is not in the ready state.

#### 'AUX UART NOT READY TO TRANSMIT'

The UART for the Auxiliary Channel transmit ready signal is not in the ready state.

#### 'DATA ERROR ON SEND FROM AUX TO COMM'

Indicates that data from the AUX Channel was not transmitted successfully or not received successfully by the COMM Channel.

#### 'DATA ERROR ON SEND FROM COMM TO AUX'

Indicates that data from the COMM Channel was not transmitted successfully or not received successfully by the AUX Channel.

**'NO RECEIVED DATA ON COMM'**

Indicates that no data was received by the COMM Channel following a transmission from the AUX Channel.

**'NO RECEIVED DATA ON AUX'**

Indicates that no data was received by the AUX Channel following a transmission from the COMM Channel.

**3.2.8.1.4 EIA loopback error messages.** The following error messages can occur only if the EIA loop back test is executed. The EIA Loop Back Connector must be installed at the Communications D Connector for these tests. The Auxiliary I/O Channel is not involved in these tests.

**'EIA TEST – ERROR ON SI'**

Indicates an error in reading COMM Channel signal SI.

**'EIA TEST – ERROR ON RI'**

Indicates an error in reading COMM Channel signal RI.

**'EIA TEST – ERROR ON CD'**

Indicates an error in reading COMM Channel signal CD.

**'EIA TEST – ERROR ON CTS'**

Indicates an error in the Clear to Send signal.

**'EIA TEST – ERROR ON DSR'**

Indicates an error in the Data Set Ready signal.

### 3.2.8.2 User Troubleshooting

#### CAUTION

DISCONNECT THE AC LINE CORD FIRST.

1. Ensure that the keyboard cable is securely connected to the jack on the video terminal.
2. Check that the AC power fuse is intact.
3. Ensure that the input power cord is plugged in and that power is available at wall outlet.
4. Check SET-UP features to ensure compatible system operation.
5. Check for KBD locked. This will normally occur during:
  - a. SAVE operations
  - b. RECALL operations (very brief)
  - c. Default restore operations (very brief)
  - d. If the terminal output buffer is filled (7 characters)
  - e. If the terminal has received an XOFF with incoming XOFF enabled (See SET-UP C Mode). If the host device does not support XOFF-XON in this direction it may be desirable to disable incoming XOFF to avoid inadvertent lock-up conditions.
6. Check for blinking OFF LINE indicator, generate XON to Host computer by pressing CTRL and S keys.
7. Attempt to correct NVR checksum problem by performing a SAVE operation.

### 3.3 OPTIONS

Bidirectional Auxiliary I/O Channel – Allows connection and control of a wide variety of peripheral devices using full duplex, serial RS-232C or 20 mA current loop (if the current loop is not in use for the Communications Channel), and selectable XON/XOFF protocol. Many operating modes and configurations are supported. Multiple baud rates, bits-per-byte, parity, number of fills, selection of line termination character, etc. may be set from the keyboard via SET-UP D Mode which is present when the Auxiliary I/O Channel option is present.

## SECTION IV PROGRAMMING DATA

### 4.1 INTRODUCTION

This section describes and lists the CIT-101 programming commands. The keyboard character code table and the 7-bit ASCII code table are also included for the programmer's convenience.

### 4.2 GENERAL

The CIT-101 provides three functions. First, the CIT-101 serves as an input device for information to the host computer and/or a peripheral device. Information is input by the operator at the keyboard. Second, the CIT-101 serves as an output device for information from the host computer and/or peripheral device. Information received from the host computer or peripheral device can be displayed on the screen. Third, the CIT-101 operates as an interface between the host computer and peripheral device. Figure 4-1 illustrates the data flow between the CIT-101, peripheral device and host computer.

This section provides programmer data on the flow of information between the CIT-101 and host. Keyboard generated codes and terminal control sequences are included.

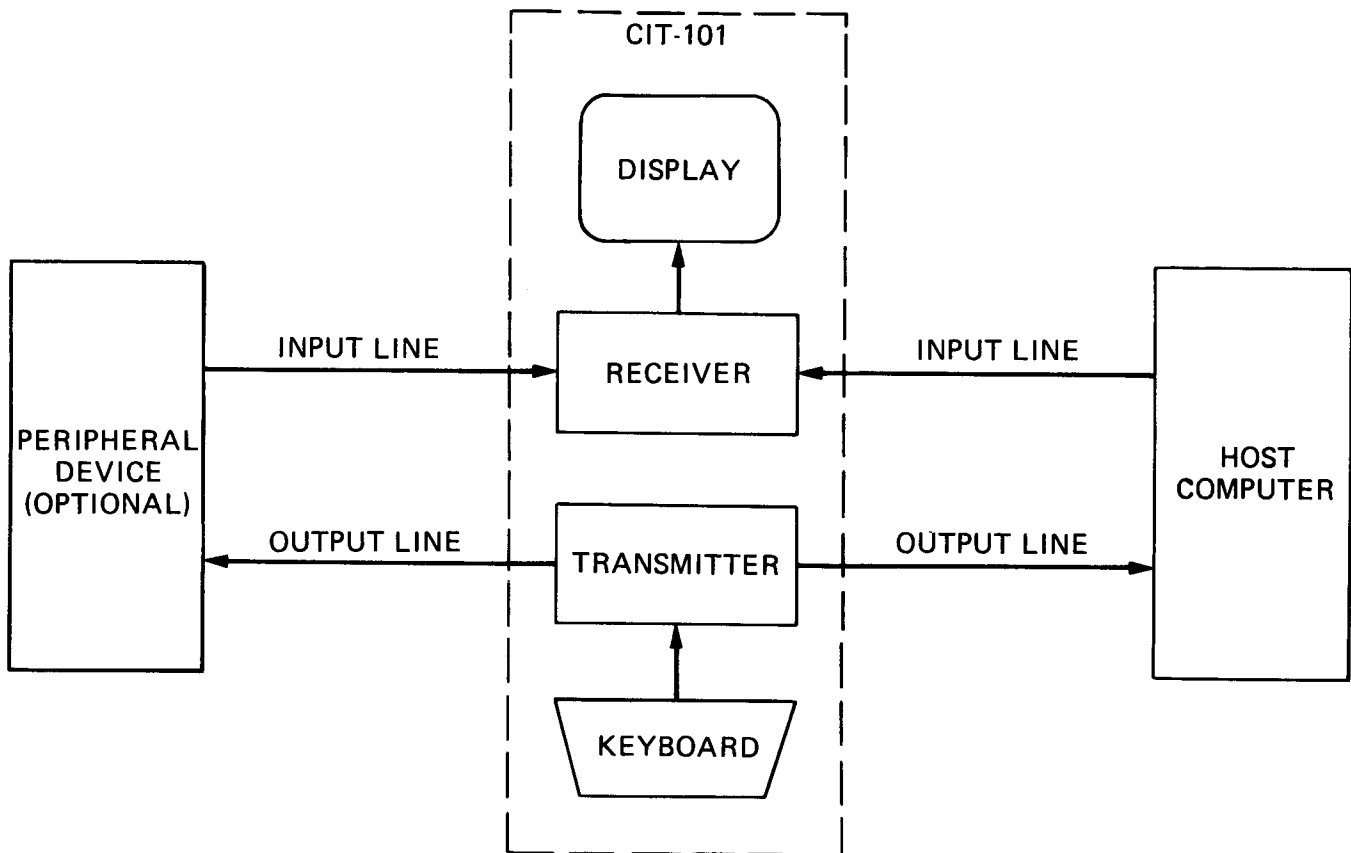

Figure 4-1. CIT-101 Data Flow

### 4.3 KEYBOARD GENERATED CODES

The keyboard generates ASCII codes for transmission to the Host Computer. The codes are standard 7-bit or 8-bit bytes and are normally transmitted immediately when a key is pressed. Some keys generate no code but modify the codes generated by other keys. If more than one key is pressed, the codes are transmitted in the order in which the keys were pressed. Pressing three keys causes two codes to be transmitted first and the third code to be transmitted when one of the first two keys is released. Note that the keyboard contains four types of keys as described in Section III. The following is a description of the use of each key type and corresponding codes.

#### 4.3.1 KEYBOARD GENERATED STANDARD CHARACTERS

The standard (printing) characters generated by the CIT-101 Keyboard are shown in Table 4-1 together with the special characters SPACE and DELETE. Note that all of these characters have an upper case function that is produced by simultaneously depressing SHIFT with the desired key.

Table 4-1. CIT-101 Keyboard Generated Standard Character Codes

Character-Octal Code	Character-Octal Code	Character-Octal Code
(space) 040	— 055 (dash)	9 071
! 041	056 (period)	: 072
" 042	/ 057	; 073
# or £ 043	0 060	< 074
\$ 044	1 061	= 075
% 045	2 062	> 076
& 046	3 063	? 077
' 047 (apostrophe)	4 064	@ 100
( 050	5 065	A 101
) 051	6 066	B 102
* 052	7 067	C 103
+ 053	8 070	D 104
, 054 (comma)		E 105

Table 4-1. CIT-101 Keyboard Generated Standard Character Codes (Continued)

Character-Octal Code		Character-Octal Code		Character-Octal Code	
F	106	Y	131	ℓ	154
G	107	Z	132	m	155
H	110	[	133	n	156
I	111	\	134	o	157
J	112	]	135	p	160
K	113	^	136	q	161
L	114	—	137	r	162
M	115	'	140	s	163
N	116	a	141	t	164
O	117	b	142	u	165
P	120	c	143	v	166
Q	121	d	144	w	167
R	122	e	145	x	170
S	123	f	146	y	171
T	124	g	147	z	172
U	125	h	150	{	173
V	126	i	151		174
W	127	j	152	}	175
X	130	k	153	~	176

### 4.3.2 KEYBOARD GENERATED CONTROL CODES

The control characters (octal values 000 through 037) can all be generated by depressing CTRL simultaneously with the appropriate key chosen from among the standard characters. These control codes are listed in Table 4-2 together with their octal values and ASCII mnemonics.

Table 4-2. Keyboard Generated Control Codes

Key*	Code	Mnemonic	Key	Code	Mnemonic
SPACE	000	NUL	P	020	DLE
A	001	SOH	Q	021	DC1
B	002	STX	R	022	DC2
C	003	ETX	S	023	DC3
D	004	EOT	T	024	DC4
E	005	ENQ	U	025	NAK
F	006	ACK	V	026	SYN
G	007	BEL	W	027	ETB
H	010	BS	X	030	CAN
I	011	HT	Y	031	EM
J	012	LF	Z	032	SUB
K	013	VT	[	033	ESC
L	014	FF	\	034	FS
M	015	CR	]	035	GS
N	016	SO	~	036	RS
O	017	SI	?	037	US

\*CTRL key is held down while indicated key is pressed.



### 4.3.3 KEYBOARD FUNCTION KEY CONTROL CODES

For user convenience and by convention, several of the control character codes may also be generated directly by simply pressing certain dedicated keys. Table 4-3 lists these function key control characters together with their octal values and functions. Note that all of these characters are also available with the use of the CTRL key and the appropriate standard keys.

A common feature of these function keys in particular and control characters in general is that the codes generated by them, if echoed by a host device or encountered in LOCAL mode, typically result in some terminal action that does not display any characters. Other classes of typical function keys not listed here are SET-UP, REPEAT, CLEAR/HOME, BREAK, etc., that are not single character control codes are described in Section III.

Table 4-3. Function Keys Control Codes

Key	Octal Code	Action
BACKSPACE	010	Backspace function
TAB	011	Tab function
LINEFEED	012	Line feed
RETURN	015	Carriage return function
ESC	033	Escape sequence delimiter
SPACE BAR	040	Space function

### 4.3.4 CURSOR KEYS

The four keys which control cursor movement generate control sequences which are transmitted to the host. When the host sends the signals back, the corresponding cursor action occurs. Table 4-4 lists the escape sequences echoed from a host cpu when the CIT-101 is ON-LINE and a cursor control key is pressed. See section 4.4.1.1 for generating these sequences from a host program.

Table 4-4. Cursor Control Key Control Sequences

Cursor Key (Arrow)	ANSI Mode with Cursor Key Mode Reset	ANSI Mode with Cursor Key Mode Set	VT52 Mode
↑ Up	<u>ESC</u> [A	<u>ESCOA</u>	<u>ESCA</u>
↓ Down	<u>ESC</u> [B	<u>ESCOB</u>	<u>ESCB</u>
→ Right	<u>ESC</u> [C	<u>ESCOC</u>	<u>ESCC</u>
← Left	<u>ESC</u> [D	<u>ESCOD</u>	<u>ESCD</u>

### 4.3.5 NUMERIC KEYPAD

The numeric keypad generates codes for numerals, decimal point, minus sign, and comma. The **ENTER** key transmits the same code as the **RETURN** key. The codes are the same as the codes generated by the corresponding key on the main keyboard.

If the host computer must distinguish between the numeric keypad and main keyboard, the terminal can be placed in a keypad application mode by the host. In the keypad application mode the keys transmit control sequences which can be used by the host as user defined functions. Table 4-5, contains the codes/code sequences generated in the keypad numeric/application modes for both ANSI and VT52 modes of operation.

Table 4-5. Numeric Keypad Generated Codes

Key	ANSI Normal Keypad Numeric Mode	ANSI Hex Keypad Numeric Mode	ANSI Keypad Application Mode	VT52 Normal Keypad Numeric Mode	VT52 Hex Keypad Numeric Mode	VT52 Keypad Application Mode
0	0	0	<u>ESC</u> Op	0	0	<u>ESC</u> ?p
1	1	1	<u>ESC</u> Oq	1	1	<u>ESC</u> ?q
2	2	2	<u>ESC</u> Or	2	2	<u>ESC</u> ?r
3	3	3	<u>ESC</u> Os	3	3	<u>ESC</u> ?s
4	4	4	<u>ESC</u> Ot	4	4	<u>ESC</u> ?t
5	5	5	<u>ESC</u> Ou	5	5	<u>ESC</u> ?u
6	6	6	<u>ESC</u> Ov	6	6	<u>ESC</u> ?v
7	7	7	<u>ESC</u> Ow	7	7	<u>ESC</u> ?w
8	8	8	<u>ESC</u> Ox	8	8	<u>ESC</u> ?x
9	9	9	<u>ESC</u> Oy	9	9	<u>ESC</u> ?y
PF1	<u>ESC</u> OP	A	<u>ESC</u> OP	<u>ESC</u> P	A	<u>ESC</u> P
PF2	<u>ESC</u> OQ	B	<u>ESC</u> OQ	<u>ESC</u> Q	B	<u>ESC</u> Q
PF3	<u>ESC</u> OR	C	<u>ESC</u> OR	<u>ESC</u> R	C	<u>ESC</u> R
PF4	<u>ESC</u> OS	D	<u>ESC</u> OS	<u>ESC</u> S	D	<u>ESC</u> S
MINUS	MINUS	E	<u>ESC</u> Om	MINUS	E	<u>ESC</u> ?m
COMMA	COMMA	F	<u>ESC</u> OI	COMMA	F	<u>ESC</u> ?I
PERIOD	PERIOD	PERIOD	<u>ESC</u> On	PERIOD	PERIOD	<u>ESC</u> ?n
ENTER	RETURN	RETURN	<u>ESC</u> OM	RETURN	RETURN	<u>ESC</u> ?M

Note that in either ANSI or VT-52 mode, control sequences must be used to put the CIT-101 into either the keypad application mode or the normal keypad numeric mode. To enter the Hex Keypad numeric mode (in VT52 mode) requires setting bit 3 of group one in SET-UP C mode. In ANSI mode, Hex Keypad numeric mode may be invoked either via a command from the host or, by setting bit 3 of group one in SET-UP C mode.

Furthermore, a fourth numeric Keypad application mode exists when the Bidirection auxiliary port is installed in the CIT-101. The command structure for this Bidirectional Auxilliary port is listed in Table 3-4.

### 4.3.6 ALTERNATE CHARACTER SET

When the alternate character set is selected (see Section 4.4.37), the character codes 040g through 176g represent the alternate character set. Table 4-6 identifies the alternate character set and octal codes. Refer to Appendix B for dot matrix configuration.

Table 4-6. CIT-101 Alternate Character Set and Octal Codes

Character-Octal Code	Character-Octal Code	Character-Octal Code
(space) 040	1 061	0 104
! 041	2 062	E 105
" 042	3 063	F 106
# 043	4 064	G 107
\$ 044	5 065	H 110
% 045	6 066	I 111
& 046	7 067	J 112
' 047	8 070	K 113
(apostrophe)	9 071	L 114
( 050	: 072	M 115
) 051	; 073	N 116
* 052	< 074	O 117
+ 053	= 075	P 120
, 054	> 076	Q 121
(comma)	? 077	R 122
- 055	@ 100	S 123
(dash)	A 101	T 124
. 056	B 102	U 125
(period)	C 103	V 126
/ 057		
0 060		

Table 4-6. CIT-101 Alternate Character Set and Octal Codes (Continued)

Character-Octal Code	Character-Octal Code	Character-Octal Code
W 127	e 145	S 163
X 130	f 146	t 164
Y 131	g 147	u 165
Z 132	h 150	v 166
[ 133	i 151	w 167
\ 134	j 152	x 170
] 135	k 153	y 171
^ 136	l 154	z 172
_ 137	m 155	}
,	n 156	174
a 141	o 157	}
b 142	p 160	~ 176
c 143	q 161	¢ 177
d 144	r 162	

### 4.3.7 GRAPHICS CHARACTER SET

When the graphics character set is selected (see para 4.4.37), the graphics for ASCII codes 137g through 176g represent the graphics character set. Table 4-7 gives the replacement graphics. Refer to Designate Character Set control sequence and to Appendix B for dot matrix configurations.

Table 4-7. The Graphics Character Set

Octal Code	Standard Character	Graphics Character	Octal Code	Standard Character	Graphics Character
137	–	Blank	157	o	– Horizontal line (Scan 1)
140	\	◆ Diamond	160	p	– Horizontal line (Scan 3)
141	a	⊠ Checkerboard	161	q	– Horizontal line (Scan 5)
142	b	$\frac{H}{T}$ Horizontal tab	162	r	– Horizontal line (Scan 7)
143	c	$\frac{F}{F}$ Form Feed	163	s	– Horizontal line (Scan 9)
144	d	$\frac{C}{R}$ Carriage return	164	t	⊔ Left “T”
145	e	$\frac{L}{F}$ Line feed	165	u	⊞ Right “T”
146	f	° Degree symbol	166	v	⊥ Bottom “T”
147	g	± Plus/minus	167	w	⊤ Top “T”
150	h	$\frac{N}{L}$ New Line	170	x	Vertical Bar
151	i	$\frac{V}{T}$ Vertical tab	171	y	≤ Less than or equal to
152	j	⌋ Lower-right corner	172	z	≥ Greater than or equal to
153	k	⌋ Upper-right corner	173	}	π Pi
154	l	⌈ Upper-left corner	174		≠ Not equal to
155	m	⌋ Lower-left corner	175	}	£ UK pound sign
156	n	+ Crossing lines	176	~	• Centered dot

### 4.3.8 ALTERNATE GRAPHICS SET

When the alternate graphics set is selected (see para 4.4.37), the character codes 137g through 176g represent the alternate graphics set. Table 4-8 identifies the alternate graphics set and octal codes. Refer to Appendix B for dot matrix configurations.

Table 4-8. Alternate Graphics Character Set

Octal Code	Standard Character	Graphics Character	Octal Code	Standard Character	Graphics Character
137	—	Blank	157	o	— Horizontal line (Scan 9 and 10)
140	\	— Horizontal line (Scan 1 and 2)	160	p	= Horizontal lines (Scan 1 & 2, Scan 9 & 10)
141	a	— Horizontal line (Scan 3 and 4)	161	l	= Horizontal lines (Scan 3 & 4, Scan 9 & 10)
142	b	■ Block (Scan 1-4)	162	r	■ Block and line (Scan 1-4, Scan 9 & 10)
143	c	— Horizontal line (Scan 5 and 6)	163	s	= Horizontal lines (Scan 5 & 6, Scan 9 & 10)
144	d	= Horizontal lines (Scan 1 & 2, 5 & 6)	164	t	≡ Horizontal lines (Scan 1 & 2, 5 & 6, 9 & 10)
145	e	■ Block (Scan 3-6)	165	u	■ Block and line (Scan 3-6, Scan 9 & 10)
146	f	■ Block (Scan 1-6)	166	v	■ Block and line (Scan 1-6, Scan 9 & 10)
147	g	— Horizontal line (Scan 7 and 8)	167	w	■ Block (Scan 7-10)
150	h	= Horizontal lines (Scan 1 & 2, 7 & 8)	170	x	■ Line and Block (Scan 1 & 2, Scan 7-10)
151	i	= Horizontal lines (Scan 3 & 4, 7 & 8)	171	6	■ Line and Block (Scan 3-4, Scan 7-10)
152	j	■ Block and line (Scan 1-4, Scan 7 & 8)	172	z	■ Blocks (Scan 1-4, ■ Scan 7-10)
153	k	■ Block (Scan 5-8)	173	}	■ Block (Scan 5-10)
154	l	■ Line and Block (Scan 1 & 2, Scan 5-8)	174		■ Line and Block (Scan 1 & 2, Scan 5-10)
155	m	■ Block (Scan 3-8)	175	}	■ Block (Scan 3-10)
156	n	■ Block (Scan 1-8)	176	~	■ Block (Scan 1-10)

## 4.4 CONTROL SEQUENCES

The CIT-101 has two modes of software compatibility; ANSI Mode and VT52 Mode. In ANSI Mode the CIT-101 is software compatible with American National Standards Institute (ANSI) standards contained in documents X3.41-1974 and X3.64-1977. In VT52 Mode the CIT-101 is software compatible with most VT52 software. Control sequences are divided according to whether they are ANSI or VT52.

### 4.4.0 ANSI MODE CONTROL SEQUENCES

The basic elements of the ANSI mode control sequences are defined as follows:

Control Sequence Introducer (CSI) – An escape sequence which introduces an expanded set of control functions by allowing an alternate interpretation of a string of characters which follow it. In the CIT-101 the CSI is ESC[ (Octal 033 followed by Octal 133).

Parameter – A string of decimal digits representing a single value (i.e. a decimal number). Leading zeros are ignored. The decimal digits are sent in the ASCII representation, 0 (Octal 60) through 9 (Octal 71). Parameter also means the value so represented.

Numeric Parameter – A parameter that represents a number, designated by Pn.

Selective Parameter – A parameter that selects one function from a group of functions, designated by Ps. In general, a control sequence with multiple selective parameters has the same effect as multiple control sequences each with one selective parameter, e.g., CSI Psa;Psb;Psc F acts identically to CSI Psa F CSI Psb F CSI Psc F.

Parameter string – A string of parameters separated by a semicolon (Octal 73).

Default – The value assumed for the argument to a function when no value is specified, or a value of 0 is given.

Final Character – The character which terminates an escape or control sequence.

An example of a valid control sequence is:

<u>ESC</u> #3	Changes line to top half of double height, double width
<u>ESC</u>	Octal 033
#	An intermediate character, Octal 043
3	Final character, Octal 063

A second example is:

<u>ESC</u> [0;2;5v	Change cursor to visible blinking underline
<u>ESC</u> [	Control Sequence Introducer (CSI), Octal 033, 133
0;2;5	Selective parameters (Ps), Octal 060, 073, 062, 073, and 065 where the “;” is a delimiter
v	Final Character, Octal 166

## ANSI Mode Control Sequences (Continued)

### NOTE

The CIT-101 control sequences defined here are valid in the ANSI Mode of operation. Unless otherwise noted, actions described are taken in response to receipt of the indicated control sequence.

Parameters are either numeric (Pn) or selective (Ps). If a location in the list is left blank or specified as 0 the default is used.

#### 4.4.1 CURSOR CONTROL SEQUENCES

The CIT-101 supports a variety of powerful cursor commands that position the cursor, scroll the Display up and down, and select a variety of cursor styles.

##### 4.4.1.1 Relative Cursor Positioning

Move cursor up	<u>ESC</u> [PnA
Move cursor down	<u>ESC</u> [PnB
Move cursor right (forward)	<u>ESC</u> [PnC
Move cursor left (backward)	<u>ESC</u> [PnD

Pn is the number of rows or columns to move the cursor. The default value is 1. If no value for Pn is entered, the cursor will move by 1 row or 1 column as appropriate. When the cursor reaches any margin (left, right, top, or bottom) it will stop there.

##### 4.4.1.2 Direct Cursor Positioning

Position cursor	<u>ESC</u> [Pn;PnH or <u>ESC</u> [Pn;Pnf
-----------------	--

Directly positions cursor at location given. The first Pn specifies row number and the second Pn specifies column number where the cursor is to be positioned. Default values are each 1.

##### 4.4.1.3 Scroll Direction

Index	<u>ESC</u> D
Reverse Index	<u>ESC</u> M

Index moves the cursor down one line without changing column position. Reverse Index moves the cursor up. These moves cause scrolling when top or bottom margins are encountered.

##### 4.4.1.4 Save and Restore Cursor and Attributes

Save cursor and attributes	<u>ESC</u> 7
Restore cursor and attributes	<u>ESC</u> 8

Saves cursor position, type, and attributes so they may later be restored.



## ANSI Mode Control Sequences (Continued)

### 4.4.1.5 New Line

New line ESCE

Moves cursor to the first position on the next line down. Causes Display to scroll when the bottom margin is encountered.

### 4.4.1.6 Cursor Attributes

Cursor attributes	<u>ESC</u> [Psv
Cursor visible	Ps = 0
Cursor invisible	1
Cursor is underline	2
Cursor is reverse block	3
Non-blinking cursor	4
Blinking cursor	5

If no value for Ps is entered the default value is 0 and the cursor becomes visible.

## 4.4.2 ERASE CONTROL SEQUENCES

The CIT-101 supports a variety of erase commands that can erase from the cursor to the beginning or end of the current line or entire Display or Scrolling Region. A second group of erase commands can erase a rectangular window spanning a single line (or column) or the entire Display.

### 4.4.2.1 Erase Within Display

Erase within Display	<u>ESC</u> [PsJ
From cursor to end of Display	Ps = 0
From start of Display to cursor	1
Entire Display	2

The default value is 0. If no value is entered the Display is erased from the cursor to the end of the screen. If the appropriate bit is set in SET-UP C Mode, the Display is erased only to the appropriate margin instead of the Display limit.

### 4.4.2.2 Erase Window

Erase Window ESC[> 3;rt;cl;rb;crJ

Erases portion of Display within window specified by parameters rt (top row), cl (left column), rb (bottom row) and cr (right column).

## ANSI Mode Control Sequences (Continued)

### 4.4.2.3 Erase Within Line

Erase within line	<u>ESC</u> [PsK
From cursor to end of line	Ps = 0
From start of line to cursor	1
Entire line	2

The default value is 0. If no value is entered line is erased from cursor to end of line.

### 4.4.2.4 Erase Window Line

Erase portion of line	<u>ESC</u> [>3;cl;crk
-----------------------	-----------------------

Erases on line containing cursor that portion within boundaries specified by cl (left column) and cr (right column).

### 4.4.3 WIDTH/HEIGHT LINE COMMANDS

These commands select Double or Single Height and Double or Single Width characters on a line at a time basis. Note that Double Width decreases the number of characters on a line by 50%. If the appropriate bit is set in SET-UP C Mode the portions of Double Width lines that are off the Display to the right will be restored if the line is converted back to Single Width. Note also that Double Height requires that the line data be given twice, once with a "top" command and once with a "bottom" command.

Double height double width top	<u>ESC</u> #3
Double height double width bottom	<u>ESC</u> #4
Single height single width (normal)	<u>ESC</u> #5
Single height double width	<u>ESC</u> #6
Double height single width top	<u>ESC</u> #:
Double height single width bottom	<u>ESC</u> #:

These commands change the line the cursor is on to the indicated format. Full Double Height characters require that the same line be repeated with the first line in top format and the second line in bottom format. Unless erase RH of DW line bit is set to preserve (SET-UP C), changing a line to Double Width will erase the Right Half of the line.

### 4.4.4 VIDEO ATTRIBUTE COMMANDS

Set video attributes	<u>ESC</u> [Psm:
Normal (no attributes)	Ps = 0
Bold	1
Underline	4
Blinking	5
Reverse video	7

The default value is 0. If no value is entered all characters received will be normal video with no other attributes set. The current attribute settings apply to all succeeding characters displayed until new attributes are set.

## ANSI Mode Control Sequences (Continued)

### 4.4.5 SCROLL

A set of commands are available that affect the size of the Scrolling Region and the rate at which smooth scrolling occurs.

#### 4.4.5.1 Set Scrolling Region

Set Scrolling Region ESC[Pn;Pnr

The first parameter value is top margin and second is bottom margin. Default is the entire screen. Note that the top most Display line is designated line 1.

#### 4.4.5.2 Set Smooth Scroll Rate

Set smooth scroll rate ESC[Pnu

Pn is the number of frame times (1/60 or 1/50 second as selected by Display Frequency) between Smooth Scroll scan line changes for the Variable Speed Smooth Scroll feature.

### 4.4.6 TABS

TAB STOPS may be individually set or cleared at the current Cursor position, cleared altogether, or added to every eighth column (DEC standard).

Set TAB STOP at current column ESCH  
Set or clear TAB STOP(s) ESC[Psg

<u>Parameter</u>	<u>Value</u>	<u>Meaning</u>
Ps	0	Clear TAB STOP at current column
Ps	3	Clear all TAB STOPS
Ps	>5	Set TAB STOPS at every 8th column

The default value is 0. If no value is entered the tab is cleared at the current column position. Note that the symbol ">" is to be taken literally as octal value 076 and not as the "greater than" operator.

## ANSI Mode Control Sequences (Continued)

### 4.4.7 BLINK ATTRIBUTES

The blink attribute commands allow for flexible control and synchronization of the cursor. The cursor may be set to blink, to stop blinking and remain on, and to stop blinking and remain off as desired.

Control blink attribute	<u>ESC</u> [Psw
Resume blinking	PS = 0
Stop blinking in OFF state	1
Stop blinking in ON state	2

The OFF state of blink means that characters with the blink attribute on are the same as characters without the blink attribute on. In the ON state the characters are stopped as if they were blinking. This can be used for half intensity characters.

### 4.4.8 LED CONTROL

These commands allow individual user programmable indicators L1 through L4 to be individually set or collectively reset.

Set LED	<u>ESC</u> [Pnq
---------	-----------------

LED number Pn is turned on. If zero all LEDs are turned off. Default is 0.

### 4.4.9 MODES

The CIT-101 has a variety of features that offer the user a choice of one of two states at any one time. These two state features are called modes and have a “set” or asserted state and a “reset” or base state. For some modes the set state is an “on” condition and the reset state is an “off” condition while for other modes the set state is one “on” condition and the reset state is another “on” condition.

#### NOTE

The last character in all of the Reset Modes listed in this section is a lower case “L” (octal value 154).

### 4.4.10 NEWLINE MODE

Set Newline mode	<u>ESC</u> [20h
Reset to LINE FEED mode	<u>ESC</u> [20l

When Newline mode is in the set state and a LINE FEED is received the active position is moved to the first position on the next line and the RETURN key generates a CARRIAGE RETURN followed by a LINE FEED each time it is pressed. When Newline mode is reset and a LINE FEED is received the active position is moved to the next line but stays in the same column position.

## ANSI Mode Control Sequences (Continued)

### 4.4.11 CURSOR KEY APPLICATION MODE

Set to Cursor Key Application mode	<u>ESC</u> [?1h
Reset to Cursor mode	<u>ESC</u> [?1l

This mode is effective only when the terminal is in ANSI mode (i.e., ESC[?2h has been sent). With Cursor Key Application and ANSI modes set, the four Cursor Control keys send special user interpretable functions such as ESCOA. If Cursor Key Application mode is reset the function keys will send ANSI cursor control commands such as ESC[A. See Table 3-4.

### 4.4.12 ANSI/VT52 MODES

Set to ANSI mode (from VT52 mode)	<u>ESC</u> <
Reset to VT52 mode	<u>ESC</u> [?2l

In set state only ANSI compatible sequences are recognized. In reset state only VT52 sequences are recognized.

### 4.4.13 80/132 COLUMN MODES

Set to 132 Column mode	<u>ESC</u> [?3h
Reset to 80 Column mode	<u>ESC</u> [?3l

In set state screen will display 132 columns. In reset state screen will display 80 columns.

### 4.4.14 SMOOTH/JUMP SCROLL MODES

Set to Smooth Scroll mode	<u>ESC</u> [?4h
Reset to Jump Scroll mode	<u>ESC</u> [?4l

In set state Display will scroll smoothly at a maximum rate of six lines per second if Normal Speed Smooth Scroll is set and twelve lines per second if Double Speed Smooth Scroll is set. In reset state scroll will jump instantaneously.

### 4.4.15 REVERSE/NORMAL SCREEN MODE

Set to Reverse Screen mode	<u>ESC</u> [?5h
Reset to Normal Screen mode	<u>ESC</u> [?5l

In set state screen will be reversed showing dark characters on a white background. In reset state screen will show white characters on a dark background. These conditions may be locally reversed under the cursor or where character attributes are other than normal.

## ANSI Mode Control Sequences (Continued)

### 4.4.16 CURSOR ORIGIN MODE

Set Cursor Origin mode	<u>ESC</u> [?6h
Reset Cursor Origin mode	<u>ESC</u> [?6l

In set state the cursor Home position is the upper left character position within set margins and screen addresses are relative to that position. In reset state the cursor Home position is the upper left character position of the Display regardless of where margins are set.

### 4.4.17 AUTO WRAPAROUND MODE

Set Auto Wraparound mode	<u>ESC</u> [?7h
Reset Auto Wraparound mode	<u>ESC</u> [?7l

In set state, any characters received when cursor is at the right margin are moved to the start of the next line. A scroll is performed if necessary and allowed. In the reset state, any characters received when the cursor is at the right margin replace any characters at that position.

### 4.4.18 AUTO REPEAT MODE

Set Auto Repeat mode	<u>ESC</u> [?8h
Reset Auto Repeat mode	<u>ESC</u> [?8l

In set state, any key (except SET-UP, ESC, NO SCROLL, TAB, RETURN, and CTRL with any key) when held down for more than 1/2 second will repeat at the rate of about 30 characters per second. In the reset state no keys will repeat. This mode does not affect operation of the REPEAT key.

### 4.4.19 DOUBLE SPEED SMOOTH SCROLL MODE

Set Double Speed Smooth Scroll	<u>ESC</u> [>1h
Reset to Normal Speed Smooth Scroll	<u>ESC</u> [>1l

In set state Smooth Scroll occurs at double the normal rate. In reset state Smooth Scroll occurs at same rate as at power-up.

### 4.4.20 VT52/VT100 STYLE SCROLL KEY MODES

Set to VT52 Style Scroll key mode	<u>ESC</u> [>2h
Reset to VT100 Style Scroll key mode	<u>ESC</u> [>2l

In set state, the NO SCROLL key will behave in VT52 mode as described in Section III (SET-UP C mode). In reset state, the NO SCROLL key will alternately generate XON and XOFF each time it is pressed (synchronized) with CTRL Q and CTRL S from the keyboard).

## ANSI Mode Control Sequences (Continued)

### 4.4.21 HEX KEYPAD NUMERIC MODE

Set Hex Keypad Numeric mode	<u>ESC</u> [>3h
Reset to Normal Keypad Numeric mode	<u>ESC</u> [>3l

In set state, the Auxiliary Keypad generates hexadecimal characters from 0 through F. Keypad must be in Numeric Mode. The extra characters A to F are generated by the following keys:

<u>Key</u>	<u>Character</u>
PF1	A
PF2	B
PF3	C
PF4	D
- (MINUS)	E
, (COMMA)	F

In reset state with the Auxiliary Keypad in Numeric Mode, the Auxiliary Keypad generates the normal decimal characters 0 through 9 as in set state but PF1 through PF4 generate control sequences and MINUS and COMMA generate their respective normal characters.

### 4.4.22 CLEAR DISPLAY/LINE FEED ON FORM FEED MODES

Set Clear Display on LINE FEED mode	<u>ESC</u> [>4h
Reset to normal LINE FEED function mode	<u>ESC</u> [>4l

In set state, any FORM FEED received will clear the Display or Scrolling Region (as set elsewhere). In reset state, a FORM FEED performs the LINE FEED function.

### 4.4.23 DISABLE INCOMING XOFF MODE

Set disable incoming XOFF mode	<u>ESC</u> [>6h
Reset process incoming XOFF mode	<u>ESC</u> [>6l

In the set state, the Keyboard will ignore XOFF (CTRL S) received from the COM Port. In the reset state, the Keyboard will illuminate the Keyboard Locked indicator and cease further transmission via the active output Port until an XON (CTRL Q) is received.

### 4.4.24 SCREEN WIDTH CHANGE WIDTH ERASE MODE

Set Screen Width Change Erase mode	<u>ESC</u> [>9h
Reset Screen Width Change Preserve mode	<u>ESC</u> [>9l

In the set state, data beyond the 80th column (Single Width characters) will be erased whenever the Display is switched from 132 Column Mode to 80 Column Mode or vice versa (DEC compatible). In the reset state, data beyond the 80th column (single width characters) is preserved on such changes.

## ANSI Mode Control Sequences (Continued)

### 4.4.25 RIGHT HALF OF DOUBLE WIDTH LINES ERASE MODE

Set RH of DW Lines Erase mode	<u>ESC[&gt;10h</u>
Reset to RH of DW Lines Preserve mode	<u>ESC[&gt;10I</u>

In the set state, the right side (off screen) portion of Double Width lines are not preserved if the Double Width line is converted to Single Width (DEC compatible). In the reset state, the right-most characters are preserved on such a transformation.

### 4.4.26 ERASE PAGE EXTENT MODE

Set erase page within margins	<u>ESC[&gt;11h</u>
Reset erase entire Display	<u>ESC[&gt;11I</u>

In the set state, a page erase or Display clear command will erase only the Scrolling Region. In the reset state, the entire Display will be erased.

### 4.4.27 TAB MOTION SPACES/DIRECT MODES

Set tab motion with spaces mode	<u>ESC[&gt;12h</u>
Reset tab motion direct	<u>ESC[&gt;12I</u>

In the set state, TAB commands are executed as though they consisted of the appropriate number of SPACE characters. In the reset state, TAB commands are executed by immediate movement of the cursor to the appropriate column with no change to any characters in intervening columns.

### 4.4.28 CRT SAVER MODE

Set CRT Saver mode	<u>ESC[&gt;13h</u>
Reset CRT Saver mode	<u>ESC[&gt;13I</u>

In the set state, the CRT Saver is engaged, causing the Screen Brightness to slowly diminish if no characters are typed or received via any active input Port over an extended time period. Receipt or typing of any such character will automatically restore the Display brightness to its previous level. In the reset state, the CRT Saver is disengaged.

### 4.4.29 HALF DUPLEX/FULL DUPLEX MODES

Set Half Duplex mode	<u>ESC[&gt;14h</u>
Reset Full Duplex mode	<u>ESC[&gt;14I</u>

In the set state, the terminal is configured for half-duplex (local echo). In the reset state, full duplex is used.



## ANSI Mode Control Sequences (Continued)

### 4.4.30 SET TIME OF DAY CLOCK

Set time	<u>ESC</u> [HH;MM;SSt
Remove clock from Display	<u>ESC</u> [t

In set state, time is set to specified parameters and displayed thereafter in Double Height, Double Width characters in the upper right corner of the Display during any SET-UP mode. Time is in 24 hour clock format where HH is hours, MM is minutes, and SS is seconds. In reset state, the clock is removed from the Display.

### 4.4.31 RESET TERMINAL

Reset terminal to initial conditions	<u>ESC</u> c
--------------------------------------	--------------

Terminal is cleared and is reset to fixed SET-UP values. Note that this function will take several seconds to occur and that XON-XOFF is not supported during this operation.

### 4.4.32 KEYPAD APPLICATION MODE

Enter Keypad Application mode	<u>ESC</u> =
Enter Keypad Numeric mode	<u>ESC</u> >

In Keypad Application mode, the Auxiliary Keypad will transmit the appropriate ANSI or VT52 mode control sequences as selected. In Keypad Numeric mode the Auxiliary Keypad will transmit ASCII values determined by user choice of normal versus hexadecimal Auxiliary Keypad.

### 4.4.33 OPTION LINE ATTRIBUTE BIT

Set option line attribute bit	<u>ESC</u> #<
Clear option line attribute bit	<u>ESC</u> #=

Selects alternate attribute set for the line the cursor is on.

### 4.4.34 SCREEN ALIGNMENT

Fill screen with E's	<u>ESC</u> #8
Fill screen with character assortment	<u>ESC</u> #9

The first control sequence fills the Display with the upper case E character while the second control sequence repeats an assortment of characters utilizing a variety of character attributes. These commands are used for alignment and test purposes.

## ANSI Mode Control Sequences (Continued)

### 4.4.35 KEYCLICK

Perform keyclick

ESC#>

When received results in keyclick.

### 4.4.36 REPORTS

A report is a character sequence sent to the host resulting from receipt of a request sequence to the terminal from the host asking for terminal parameters and status.

#### 4.4.36.1 Request For Terminal Status

ESC[5n

Response that terminal is OK

ESC[n

or

ESC[On

Response that terminal is not OK

ESC[3n

#### 4.4.36.2 Request For Cursor Position

ESC[6n

Response with cursor position

ESC[P1;PcR

#### NOTE

P1 is cursor row number

Pc is cursor column number

#### 4.4.36.3 Request Device Attributes

ESC[c

or

ESC[0c

Response with attributes

ESC[?1;2c

#### NOTE

Terminal will also respond in same manner to ESCZ. Use of this sequence, however, is not recommended and may not be supported in future versions.

## ANSI Mode Control Sequences (Continued)

### 4.4.36.4 Request For Terminal Parameters

ESC[<sol>x

<u>Parameter</u>	<u>Value</u>	<u>Meaning</u>
<sol>	0 or none	This sequence is a report request and the terminal may send unsolicited reports.  An unsolicited report is sent when the terminal exits SET-UP mode.
	1	This sequence is a report request and the terminal may send reports only when requested (default condition when the terminal is powered on).

#### Terminal parameter report

ESC[<sol>;<par>;<nbits>;<Xspeed>;<rspeed>;<clkmul>;<flag>x

<u>Parameter</u>	<u>Value</u>	<u>Meaning</u>
<sol>	2	This message is an unsolicited report
	3	This message is a report sent on request
<par>	1	Parity is not set
	4	Parity is odd
	5	Parity is even
<nbits>	1	Serial data characters are 8 bits long
	2	Serial data characters are 7 bits long
<xspeed>	0	Transmit rate is 50 Baud
	1	Transmit rate is 10 Baud
	2	Transmit rate is 2 Baud
	8	Transmit rate is 75 Baud
	16	Transmit rate is 110 Baud
	24	Transmit rate is 134.5 Baud
	32	Transmit rate is 150 Baud
	40	Transmit rate is 200 Baud
	48	Transmit rate is 300 Baud
	56	Transmit rate is 600 Baud
	64	Transmit rate is 1200 Baud
	72	Transmit rate is 1800 Baud
	80	Transmit rate is 2000 Baud
	88	Transmit rate is 2400 Baud
	96	Transmit rate is 3600 Baud
104	Transmit rate is 4800 Baud	
112	Transmit rate is 9600 Baud	
120	Transmit rate is 19200 Baud	

## ANSI Mode Control Sequences (Continued)

### Terminal parameter report (Continued)

<u>Parameter</u>	<u>Value</u>	<u>Meaning</u>
<rspeed>	0	Receive rate is 50 Baud
	1	Receive rate is 10 Baud
	2	Receive rate is 2 Baud
	8	Receive rate is 75 Baud
	16	Receive rate is 110 Baud
	24	Receive rate is 134.5 Baud
	32	Receive rate is 150 Baud
	40	Receive rate is 200 Baud
	48	Receive rate is 300 Baud
	56	Receive rate is 600 Baud
	64	Receive rate is 1200 Baud
	72	Receive rate is 1800 Baud
	80	Receive rate is 2000 Baud
	88	Receive rate is 2400 Baud
	96	Receive rate is 3600 Baud
	104	Receive rate is 4800 Baud
112	Receive rate is 9600 Baud	
120	Receive rate is 19200 Baud	
<clkmul>	1	Bit rate multiplier is 16
<flags>	0 to 15	Decimal encoded binary value as set by four user set flag bits in Group 5 of SET-UP B Mode.

#### 4.4.37 DESIGNATE CHARACTER SET

G0 character set

UK character set	<u>ESC(A</u>
ASCII character set	<u>ESC(B</u>
Graphics character set	<u>ESC(0</u>
Alternate character set	<u>ESC(1</u>
Special graphics set	<u>ESC(2</u>

## ANSI Mode Control Sequences (Continued)

### Designate Character Set (Continued)

G1 character set

UK character set	<u>ESC</u> )A
ASCII character set	<u>ESC</u> )B
Graphics character set	<u>ESC</u> )O
Alternate character set	<u>ESC</u> )1
Special graphics set	<u>ESC</u> )2

### 4.4.38 BIDIRECTIONAL AUXILIARY PORT CONTROL

Keyboard data to Communications Port	<u>ESC</u> [0z
Keyboard data to Auxiliary Port	<u>ESC</u> [1z
Auxiliary Port to Communications Port	<u>ESC</u> [2z
Auxiliary Port to Display	<u>ESC</u> [3z
Cease input from Auxiliary Port	<u>ESC</u> [4z
Clear Auxiliary Port output buffer	<u>ESC</u> [5z
Enter Auto Auxiliary Mode	<u>ESC</u> #0
Exit Auto Auxiliary or Concurrent Auxiliary Modes	<u>ESC</u> #1
Output Cursor Display Line to Auxiliary	<u>ESC</u> #2
Output Display Page to Auxiliary	<u>ESC</u> #7
Enter Concurrent Auxiliary Mode	<u>ESC</u> O
Enter Auxiliary Control Mode	<u>ESC</u> 1
Exit Auxiliary Control Mode	<u>ESC</u> 2

### 4.4.39 SUMMARY OF ANSI CONTROL SEQUENCES

Table 4-9 is a summary of valid CIT-101 ANSI mode control and escape sequences.

**Table 4-9. Summary of ANSI Mode Control Sequences**

#### NOTE

Default value of actions defined, if applicable, are given in parentheses at the end of each line.

Sequence	Action
<u>ESC</u> #0	Enter Auto Auxiliary Mode
<u>ESC</u> #1	Exit Auto Auxiliary or Concurrent Auxiliary Modes
<u>ESC</u> #2	Output cursor line to Auxiliary
<u>ESC</u> #3	Change cursor line to double height (DH) double width (DW) top half
<u>ESC</u> #4	Change cursor line to DH DW bottom half
<u>ESC</u> #5	Change cursor line to single height (SH) single width (SW)

ANSI Mode Control Sequences (Continued)

Table 4-9. Summary of ANSI Mode Control Sequences (Continued)

Sequence	Action
<u>ESC</u> #6	Change cursor line to SH DW
<u>ESC</u> #7	Output Page to Auxiliary
<u>ESC</u> #8	Fill screen with E's
<u>ESC</u> #9	Fill screen with character assortment
<u>ESC</u> #:	Change cursor line to DH SW top half
<u>ESC</u> #;	Change cursor line to DH SW bottom half
<u>ESC</u> #<	Set option line attribute bit
<u>ESC</u> #=	Clear option line attribute bit
<u>ESC</u> #>	Perform keyclick
<u>ESC</u> (A	Designate UK character set as G0
<u>ESC</u> (B	Designate ASCII character set as G0
<u>ESC</u> (0	Designate graphics character set as G0
<u>ESC</u> (1	Designate alternate character set as G0
<u>ESC</u> (2	Designate alternate graphics set as G0
<u>ESC</u> )A	Designate UK character set as G1
<u>ESC</u> )B	Designate ASCII character set as G1
<u>ESC</u> )0	Designate graphics character set as G1
<u>ESC</u> )1	Designate alternate character set as G1
<u>ESC</u> )2	Designate alternate graphics set as G1
<u>ESC</u> 0	Enter Concurrent Auxiliary Mode
<u>ESC</u> 1	Enter Auxiliary Control Mode
<u>ESC</u> 2	Exit Auxiliary Control Mode
<u>ESC</u> 7	Save cursor and attributes
<u>ESC</u> 8	Restore cursor and attributes
<u>ESC</u> =	Enter keypad application mode
<u>ESC</u> >	Enter keypad numeric mode
<u>ESC</u> D	Move cursor down one line
<u>ESC</u> E	Move cursor to first character position next line down
<u>ESC</u> H	Set tab at current column
<u>ESC</u> M	Move cursor up one line
<u>ESC</u> Z	Transmit identity sequence (Nonstandard ANSI)
<u>ESC</u> c	Reset terminal to initial state
<u>ESC</u> [PnA	Move cursor up n lines (1)
<u>ESC</u> [PnB	Move cursor down n lines (1)
<u>ESC</u> [PnC	Move cursor forward (right) n places (1)
<u>ESC</u> [PnD	Move cursor back (left) n places (1)
<u>ESC</u> [Pn;PnH	Position cursor to n row, n column (1, 1)
<u>ESC</u> [0J	Erase from cursor to end of display (0)
<u>ESC</u> [1J	Erase from beginning of display to cursor
<u>ESC</u> [2J	Erase entire display
<u>ESC</u> [>3;RT;CL;RB;CRJ	Erase all within top row (RT); left column (CL), bottom row (RB), right column (CR)

## ANSI Mode Control Sequences (Continued)

Table 4-9. Summary of ANSI Mode Control Sequences (Continued)

Sequence	Action
<u>ESC</u> [0K	Erase from cursor to end of line (0)
<u>ESC</u> [1K	Erase from beginning of line to cursor
<u>ESC</u> [2K	Erase entire line
<u>ESC</u> [>3;CL:CRK	Erase within line from left column (CL) to right column (CR)
<u>ESC</u> [c or <u>ESC</u> [0c	Report device attributes, response is:  <u>ESC</u> [?1;2c (AVO option included)
<u>ESC</u> [Pn;Pnf	Same as <u>ESC</u> [Pn;PnH (1, 1)
<u>ESC</u> [0g	Clear tab at cursor column position (0)
<u>ESC</u> [3g	Clear all TAP STOPS
<u>ESC</u> [>5g	Set tabs every 8 columns
<u>ESC</u> [20h	Set new line mode
<u>ESC</u> [?1h	Set cursor key application mode
<u>ESC</u> [?2h	Set ANSI mode
<u>ESC</u> [?3h	Set 132 column mode
<u>ESC</u> [?4h	Set smooth scroll mode
<u>ESC</u> [?5h	Set reverse screen mode
<u>ESC</u> [?6h	Set origin mode
<u>ESC</u> [?7h	Set auto wraparound mode
<u>ESC</u> [?8h	Set auto repeat mode
<u>ESC</u> [>1h	Set double speed smooth scroll mode
<u>ESC</u> [>2h	Set VT52 style scroll key
<u>ESC</u> [>3h	Set hex keypad mode
<u>ESC</u> [>4h	Set clear screen on FORM FEED
<u>ESC</u> [>5h	Set control characters visible
<u>ESC</u> [>6h	Set ignore incoming XOFF
<u>ESC</u> [>9h	Set clear screen on 80/132 change
<u>ESC</u> [>10h	Set erase RH of DW lines
<u>ESC</u> [>11h	Set erase page within margins
<u>ESC</u> [>12h	Set TAB command with SPACES
<u>ESC</u> [>13h	Set CRT Saver enabled
<u>ESC</u> [>14h	Set Half Duplex
<u>ESC</u> [20l	Reset to LINE FEED from New Line mode
<u>ESC</u> [?1l	Reset Cursor Key Application mode
<u>ESC</u> [?2l	Reset to VT52 mode
<u>ESC</u> [?3l	Reset to 80 Column mode
<u>ESC</u> [?4l	Reset to Jump Scroll mode
<u>ESC</u> [?5l	Reset to normal screen from reverse screen
<u>ESC</u> [?6l	Reset to Cursor Origin mode
<u>ESC</u> [?7l	Reset Auto Wraparound mode
<u>ESC</u> [?8l	Reset Auto Repeat mode
<u>ESC</u> [>1l	Reset to Normal Speed Smooth Scroll mode
<u>ESC</u> [>2l	Reset to VT52 Style Scroll key

ANSI Mode Control Sequences (Continued)

Table 4-9. Summary of ANSI Mode Control Sequences (Continued)

Sequence	Action
<u>ESC</u> [>3l	Reset to Normal (non-hexadecimal) Keypad mode
<u>ESC</u> [>4l	Reset to FORM FEED is LINE FEED
<u>ESC</u> [>6l	Reset to incoming XOFF enabled
<u>ESC</u> [>9l	Reset to screen data on width change preserved
<u>ESC</u> [>10l	Reset to RH of DW lines preserved on change
<u>ESC</u> [>11l	Reset to erase full screen on clear commands
<u>ESC</u> [>12l	Reset to TAB motion direct
<u>ESC</u> [>13l	Reset CRT saver
<u>ESC</u> [>14l	Reset to Full Duplex
<u>ESC</u> [0m	Select normal graphic rendition, visual with no attributes (0)
<u>ESC</u> [1m	Select bold characters
<u>ESC</u> [4m	Underline characters
<u>ESC</u> [5m	Blink characters
<u>ESC</u> [7m	Select reverse video characters
<u>ESC</u> [5n	Report terminal status, response is:  <u>ESC</u> [0n      Terminal is OK <u>ESC</u> [3n      Terminal is not OK
<u>ESC</u> [6n	Report cursor position, response is:  <u>ESC</u> [P1;PcR    P1 = line, Pc = column
<u>ESC</u> [0q	Turn off all LEDs (0)
<u>ESC</u> [Pnq	Turn on LED n; n = 1 through 4 (0)
<u>ESC</u> [RT;RBr	Set Scrolling Region at top row (RT) and bottom row (RB) (Default is entire screen)
<u>ESC</u> [HH;MM;SSt	Set time of day clock to hours (HH) minutes (MM) and seconds (SS), 24 hour format
<u>ESC</u> [t	Disable time of day clock
<u>ESC</u> [Pnu	Set scroll rate to Pn ticks (1/60th of second) between scan line scrolls.
<u>ESC</u> [0v	Make cursor visible (0)
<u>ESC</u> [1v	Make cursor invisible
<u>ESC</u> [2v	Make cursor underline
<u>ESC</u> [3v	Make cursor reverse block
<u>ESC</u> [4v	Make cursor non-blinking
<u>ESC</u> [5v	Make cursor blink
<u>ESC</u> [0w	Enable blinking attribute (0)
<u>ESC</u> [1w	Freeze blinking in the OFF state
<u>ESC</u> [2w	Freeze blinking in the ON state



## ANSI Mode Control Sequences (Continued)

Table 4-9. Summary of ANSI Mode Control Sequences (Continued)

Sequence	Action
<u>ESC</u> [<sol>x	Request terminal status, response is:
<u>ESC</u> [<sol>;<par>;<nbits>;<xspeed>;<rspeed>;<clkmul>;<flags>x	
<sol>=0	This message is a request and the terminal may send unsolicited reports.
<sol>=1	This is a request, terminal may send report only on request.
<sol>=2	This message is an unsolicited report
<sol>=3	This message is a report sent on request
<par>=1	No parity set
<par>=4	Parity is set and odd
<par>=5	Parity is set and even
<nbits>=1	8 bits per character
<nbits>=2	7 bits per character
<xspeed>	Data transmission baud rate
<rspeed>	Data reception baud rate
<clkmul>=1	Bit rate multiplier is 16
<flags>=0 to 15	Decimal encoded binary number representing the four switch values in Group 5 of SET-UP B Mode.
<u>ESC</u> [2;1y	Invoke power-up diagnostic test
<u>ESC</u> [2;2y	Invoke dual port loop back test
<u>ESC</u> [2;4y	Invoke EIA loop back test
<u>ESC</u> [2;Psy	Invoke specified test
<u>ESC</u> [0z	Keyboard data to Communications Port
<u>ESC</u> [1z	Keyboard data to Auxiliary Port
<u>ESC</u> [2z	Auxiliary Port to Communications Port
<u>ESC</u> [3z	Auxiliary Port to Display
<u>ESC</u> [4z	Cease input from Auxiliary Port
<u>ESC</u> [5z	Clear printer buffer
<u>ESC</u> [Pn-	Testing sequences – used during manufacture and test and should not be invoked by the user. (Included here only for completeness.)

## VT-52 Mode Control Sequences

### 4.4.40 VT52 MODE CONTROL SEQUENCES

The CIT-101 control sequences defined here are valid in the VT52 Mode of operation. Unless otherwise noted, actions described are taken in response to receipt of the indicated control sequence.

#### 4.4.40.1 Cursor Control Sequences

Move cursor up	<u>ESCA</u>
Move cursor down	<u>ESCB</u>
Move cursor right	<u>ESCC</u>
Move cursor left	<u>ESCD</u>

Move cursor one row, up or down, or one column, left or right, as specified. Cursor will not move beyond margin limits.

##### 4.4.40.1.1 Move cursor home ESCH

Move cursor to the home position at upper left corner of Display.

##### 4.4.40.1.2 Position cursor ESCYrc

Position cursor to specified row (r) and column (c). Row and column values are sent in ASCII code plus octal 37. For example row 2 is octal 41 (37+2).

#### 4.4.40.2 Erase Control Sequences

Erase to end of line	<u>ESCK</u>
Erase to end of page	<u>ESCJ</u>

Erase screen from cursor to end of line or page as indicated.

#### 4.4.40.3 Graphics Mode

Enter special graphics mode	<u>ESCF</u>
Exit special graphics mode	<u>ESCG</u>

Use special graphic character set when in graphics mode.

#### 4.4.40.4 Keypad Application Mode

Enter Keypad Application mode	<u>ESC=</u>
Exit Keypad Application mode	<u>ESC&gt;</u>

Use special applications control sequences from the Auxiliary Keypad.

## VT-52 Mode Control Sequences (Continued)

### 4.4.40.5 Hold Screen Mode

Hold Screen Mode ON	<u>ESC</u> [
Hold Screen Mode OFF	<u>ESC</u> \

Enable/disable VT52 Hold Screen Mode for Display control when using VT52 Style Scroll Mode commands (see NO SCROLL KEY in section III).

### 4.4.40.6 Bidirectional Auxiliary Port Control

Enter Concurrent Auxiliary mode	<u>ESCU</u>
Output cursor line to Auxiliary	<u>ESC</u> V
Enter Auxiliary Controller mode	<u>ESC</u> W
Exit Auxiliary controller mode	<u>ESC</u> X
Output full screen to Auxiliary	<u>ESC</u> ]
Exit Auto Auxiliary mode	<u>ESC</u> ^
Enter Auto Auxiliary mode	<u>ESC</u>

### 4.4.40.7 Scroll

Reverse line feed	<u>ESC</u> I
-------------------	--------------

Move cursor up one row in same column. If cursor is at the top margin, a scroll down is performed.

### 4.4.40.8 ANSI Mode

Enter ANSI mode	<u>ESC</u> <
-----------------	--------------

Exit VT52 mode and enter ANSI mode.

### 4.4.40.9 Request Identity

Identify terminal type	<u>ESC</u> Z
------------------------	--------------

Transmit identifier sequence	<u>ESC</u> /Z
------------------------------	---------------

## VT-52 Mode Control Sequences (Continued)

### 4.4.40.10 Summary Of VT-52 Control Sequences

Table 4-10 is a summary of Valid CIT-101 VT-52 mode control sequences.

**Table 4-10. Summary of VT52 Mode Control Sequences**

Sequence	Action
<u>ESC</u> <	Enter ANSI mode from VT52 mode
<u>ESC</u> =	Enter alternate keypad mode
<u>ESC</u> >	Exit alternate keypad mode
<u>ESCA</u>	Move cursor up one row
<u>ESCB</u>	Move cursor down one row
<u>ESCC</u>	Move cursor right one column
<u>ESCD</u>	Move cursor left one column
<u>ESCF</u>	Enter special graphics mode
<u>ESCG</u>	Exit special graphics mode
<u>ESCH</u>	Move cursor to home position
<u>ESCI</u>	Reverse line feed
<u>ESCJ</u>	Erase to end of page
<u>ESCK</u>	Erase to end of line
<u>ESCU</u>	Enter Concurrent Auxiliary mode
<u>ESCV</u>	Output cursor line to Auxiliary Port
<u>ESCW</u>	Enter Auxiliary Controller mode
<u>ESCX</u>	Exit Auxiliary Controller mode
<u>ESCY</u>	Direct cursor addressing
<u>ESCZ</u>	Identify terminal type
<u>ESC</u> [	Hold screen mode on
<u>ESC</u> \	Hold screen mode off
<u>ESC</u> ]	Output full screen to Auxiliary Port
<u>ESC</u> ^	Exit Auto Auxiliary mode
<u>ESC</u>	Enter Auto Auxiliary mode

#### 4.4.41 ASCII TABLE

Table 4-11 contains a complete 7-bit ASCII table for the CIT-101 showing the octal and hexadecimal values together with ASCII mnemonics for all 96 characters.

Table 4-11. Standard 7-Bit ASCII Code

Octal Code	Character	Octal Code	Character	Octal Code	Character	Octal Code	Character
000	NUL	023	DC3	046	&	071	9
001	SOH	024	DC4	047	'	072	:
002	STX	025	NAK	050	(	073	;
003	ETX	026	SYN	051	)	074	<
004	EOT	027	ETB	052	*	075	=
005	ENQ	030	CAN	053	+	076	>
006	ACK	031	EM	054	,	077	?
007	BEL	032	SUB	055	-	100	@
010	BS	033	ESC	056	.	101	A
011	HT	034	FS	057	/	102	B
012	LF	035	GS	060	0	103	C
013	VT	036	RS	061	1	104	D
014	FF	037	US	062	2	105	E
015	CR	040	SP	063	3	106	F
016	SO	041	!	064	4	107	G
017	SI	042	"	065	5	110	H
020	DLE	043	#	066	6	111	I
021	DC1	044	\$	067	7	112	J
022	DC2	045	%	070	8	113	K

Table 4-11. Standard 7-Bit ASCII Code (Continued)

Octal Code	Character	Octal Code	Character	Octal Code	Character	Octal Code	Character
114	L	123	S	132	Z	141	a
115	M	124	T	133	[	142	b
116	N	125	U	134	\	143	c
117	O	126	V	135	]	144	d
120	P	127	W	136	^	145	e
121	Q	130	X	137	-	146	f
122	R	131	Y	140	'	147	g

#### 4.4.42 SELF-TEST DIAGNOSTICS

These ANSI-only commands perform a variety of diagnostic self-tests in the CIT-101. Note that if continuous testing is selected, control of the terminal can only be regained if an error is detected or by placing Power OFF and back ON. See Section III for further information about Self-Test Diagnostics and terminal response via Error Messages.

Self test

ESC[2;Psy

where "Ps" is a parameter chosen for the desired test(s) as follows:

<u>Function Tested</u>	<u>Parameter</u>
Same as power up ROM NVR RAM	1
Dual port loop back Com Port to Aux Port	2*
EIA loop back	4**
Continuous testing of selected functions	8

\*Requires Dual Port Loop Back Connector

\*\*Requires EIA Loop Back Connector

To perform more than one of the first three above enumerated functions, or to perform selected functions continuously until a failure is detected, use a parameter equal to the sum of those parameters given for the functions desired. These commands function only in ANSI mode, not in VT52 mode.

## SUBJECT INDEX

	Page
AC line voltage select switch .....	2-4
Control Sequences .....	4-4
ANSI .....	4-4
VT52 .....	4-30
Connectors .....	2-8
Communication .....	2-8
Printer .....	2-8
Current Loop interface .....	2-8
Diagnostics .....	3-25
Error Messages .....	3-25
Installation .....	2-4
Keyboard .....	3-1
Indicators .....	3-9
Keypad .....	3-6
Standard Keys .....	3-2
Terminal control keys .....	3-2
Options .....	3-28
Transmission Protocol .....	2-8
SET-UP modes .....	3-10
A .....	3-12
B .....	3-13
C .....	3-16
D .....	3-20
Unpacking .....	2-2



## APPENDIX A ANSI DEFINITIONS

This appendix provides definitions of ANSI terms as they relate to the information contained in this document and the CIT-101 terminal. For further definitions of ANSI terms refer to ANSI documents X3/TR-1-77, X3.4-1977, X3.41-1974 and X3.64-1979.

**active position.** The character position in a visual display that is to image the graphic symbol representing the next graphic or control character for which a graphic representation is required.

**control character.** A character whose occurrence in a particular context initiates, modifies, or stops a control function.

**control function.** An action that affects the recording, processing, transmission, or interpretation of data.

**control sequence.** A sequence of characters that is used for control purposes to perform a control function. It begins with the Control Sequence Introducer (CSI) control character and may contain a parameter string.

**Control Sequence Introducer (CSI).** A control character (in 8 bits) or an Escape sequence (in 7 bits) that provides supplementary controls and that is itself a prefix affecting the interpretation of a limited number of contiguous bit combinations.

**control string.** A string of characters that is used to perform a control function and is delimited by an opening and closing delimiter control.

**cursor.** A visual representation of the active position.

**default.** A function-dependent value that is assumed when no explicit value is specified.

**designate.** To identify a set of characters that are to be represented, in some cases immediately and in others on the occurrence of a further control function, in a prescribed manner.

**Editor function.** A control that effects the layout or positioning of previously entered or received information in a character imaging device (for example, a printing or cathode ray tube device) and is intended to be interpreted and executed without remaining in the data stream.

**Escape character (ESC).** A control character that provides supplementary characters (code extension) and is itself a prefix affecting the interpretation of a limited number of contiguous bit combinations.

**Escape sequence.** A sequence of characters that is used for control purposes to perform a control function and whose first character is the Escape (ESC) control character.

**Final character.** A character whose bit combination terminates an escape or control sequence.

**line.** A set of adjacent character positions in a visual display that have the same vertical position.

**mode.** A state of a device, or other sender or recipient, that affects the interpretation of received information, the operation of the sender or recipient, or the format of the transmitted information.

**numeric parameter.** A string of bit combinations that represents a number.

**parameter.**

(1) A string of one or more bit combinations representing a single value.

(2) The value so represented.

**parameter string.** A string of bit combinations that represent one or more parameter values.

**scroll.** An action whereby all of the graphic symbols of a visual display are moved in a specified direction.

**selective parameter.** A string of bit combinations that selects a subfunction from a specified list of subfunctions.

**string delimiter.** A control that begins or ends a string of characters in a data stream.

# APPENDIX B

## DOT MATRIX CONFIGURATIONS

### GRAPHICS CHARACTER SET

137*	140	141	142	143	144	145	146
*** * * * ** * * * * * ** * * * * ***	* *** ***** ***** *** *	* * * * * * * * * * * * * * * * * * * *	* * * * *** * * * *** * * *	*** * ** * *** * * ** * * *	*** * * ***** * * *** * * * *	* * * * *** **** ** * *	** * * * * **
147	150	151	152	153	154	155	156
* * ***** * *****	* * ** * * ** * * * *****	* * * * * * * * * * * * *	* * * * ***** * * *	* * * * ***** * * * *	* * * * * * * * *	* * * * * ***** *****	* * * * * * * * *
157	160	161	162	163	164	165	166
*****	*****	*****	*****	*****	* * * * * * * *	* * * * * * * *	* * * * * *****
167	170	171	172	173	174	175	176
***** * * * *	* * * * * * *	* * * * * * * *****	* * * * * * * * * * *****	* * * * * * * * * * *	* * * * * * * * *	** * * * ***** * ***** * * **	* *

\*OCTAL CODES

# ASCII CHARACTER SET

040*	041	042	043	044	045	046	047
	* * * *	* * * * * *	* * * * ***** * * ***** * * * * * *	* ***** * * ***** * * ***** * *	** * * * * * * * * * * *	** * * * * * * * * ** * ** * ** *	** * *
050	051	052	053	054	055	056	057
* * * * *	* * * * *	* * * * ***** * * * *	* * ***** * *	** * *	*****	** **	* * * * * *
060	061	062	063	064	065	066	067
***** * ** * * * * * * ** * *****	* ** * * * * ***	*** * * * * *****	***** * * ** * * ***	* ** * * * * ***** * *	***** * ***** * * * * ***	** * ***** * * ***	***** * * * * *
070	071	072	073	074	075	076	077
**** * * * * * * **** * * * ****	*** * * * * * * * * * * *	** ** ** **	** ** ** * *	* * * * *	***** *****	* * * * *	**** * * * * *

\*OCTAL CODES

# ASCII CHARACTER SET (Cont'd)

100*	101	102	103	104	105	106	107
***** * * * * * * * * * * * * * * * * * *	*** * * * * * * * * * * * * * * * *	***** * * * * * * * * * * * * * * * * * *	*** * * * * * * * * * * * *	***** * * * * * * * * * * * * * * * * * *	***** * * * * * * * * * * * * * * * * * *	***** * * * * * * * * * * * * * * * * * *	*** * * * * * * * * * * * * * * * *
110	111	112	113	114	115	116	117
* * * * * * * * * * * * * * * * *	*** * * * * * * * * * * * ***	*** * * * * * * * * * * * ***	* * * * * * * * * * * * * * * * *	* * * * * * * * * * * * * * *****	* *	* *	*** * * * * * * * * * * * * * ***
120	121	122	123	124	125	126	127
***** * * * * * * * * * * * * * * * *	***** * * * * * * * * * * * * * * * * * *	***** * * * * * * * * * * * * * * * *	*** * * * * * * * * * * * * * ***	***** * * * * * * * * * * * * * * * *	* * * * * * * * * * * * * * * * * * ***	* * * * * * * * * * * * * * * * * * *	* *
130	131	132	133	134	135	136	137
* *	* * * * * * * * * * * * * * * * * * *	***** * * * * * * * * * * * * * *****	*** * * * * * * * * * * * * * ***	* * * * * * * * * * * * * * * * *	*** * * * * * * * * * * * * * ***	* * * * * * * * * * * * * * * * * *	*****

\*OCTAL CODES

# ASCII CHARACTER SET (Cont'd)

140*	141	142	143	144	145	146	147
** * *	*** * *** * ***	* * * ** ** * * * * **	*** * * * * ****	* * ** * * ** * ** ****	*** * * **** * ****	*** * * **** * *	*** * * * * * * **** * * ***
150	151	152	153	154	155	156	157
* * * ** ** * * * * *	* * * * *	* * * * * * * ***	* * * * * * ** * * *	* * * * * *	*** ** * * * * * * * * * * *	* *** ** * * * * * * *	*** * * * * * * ***
160	161	162	163	164	165	166	167
**** * * * * **** * * *	*** * * * * **** * ** *	* *** ** * * * * *	**** * *** * ****	***** * * * **	* * * * * * * * * * *** *	* * * * * * * * * *	* * * * * * * * * * ** **
170	171	172	173	174	175	176	177
* * * * * * * * *	* * * * * * **** * * ***	***** * * * *****	** * * *** * **	* * * * * *	** * * *** * **	**** * * * * *	* * * * * * * * * * * * * *

\*OCTAL CODES

# ALTERNATE GRAPHIC CHARACTER SET

137*	140	141	142	143	144	145	146
*****		*****		*****	*****		*****
*****		*****		*****	*****		*****
		*****	*****			*****	*****
		*****	*****			*****	*****
				*****	*****	*****	*****
				*****	*****	*****	*****
147	150	151	152	153	154	155	156
*****		*****		*****	*****		*****
*****		*****		*****	*****		*****
		*****	*****			*****	*****
		*****	*****			*****	*****
				*****	*****	*****	*****
				*****	*****	*****	*****
*****	*****	*****	*****	*****	*****	*****	*****
*****	*****	*****	*****	*****	*****	*****	*****
157	160	161	162	163	164	165	166
*****		*****		*****	*****		*****
*****		*****		*****	*****		*****
		*****	*****			*****	*****
		*****	*****			*****	*****
				*****	*****	*****	*****
				*****	*****	*****	*****
*****	*****	*****	*****	*****	*****	*****	*****
*****	*****	*****	*****	*****	*****	*****	*****
167	170	171	172	173	174	175	176
*****		*****		*****	*****		*****
*****		*****		*****	*****		*****
		*****	*****			*****	*****
		*****	*****			*****	*****
				*****	*****	*****	*****
				*****	*****	*****	*****
*****	*****	*****	*****	*****	*****	*****	*****
*****	*****	*****	*****	*****	*****	*****	*****
*****	*****	*****	*****	*****	*****	*****	*****
*****	*****	*****	*****	*****	*****	*****	*****

\*OCTAL CODES

# ALTERNATE CHARACTER SET

040*	041	042	043	044	045	046	047
	*	** **	* *	*	*****	*****	**
	*	** **	*****	*	*****	*****	**
	**	** **	* *	*	*	**	**
	**		* *	*****	*	*****	
	**		*****	**	*	* *	
	**		* **	**	* **	* ****	
	**		* **	*****	* **	*****	
				*			
050	051	052	053	054	055	056	057
**	**	* *					***
*****	*****	**	**				**
*	*	*****	**		****		**
*	*	**	*****		*****		*
*	*	* *	*				**
*****	*****	* *	*	**		**	**
***	***			**		**	***
				*			
				*			
060	061	062	063	064	065	066	067
*****	**	*****	*****	** *	*****	*****	*****
* *	**	* *	* *	** *	*	* *	**
* *	*	*	*	** *	*	*	**
* **	*	*****	****	*****	*****	*****	*
* **	***	*	*	*	**	* **	*
* **	***	* **	*** *	*	**	* **	*
*****	***	*****	*****	*	*****	*****	*
070	071	072	073	074	075	076	077
****	*****			***		***	*****
* *	* *	**	**	**		**	*
* *	* *	**	**	****	*****	****	*
*****	*****			**		**	*****
* *	**			****	*****	****	**
* *	**	**	**	**	*****	**	**
*****	**	**	**	***		***	**
			*				
			*				

\*OCTAL CODES



ALTERNATE CHARACTER SET (Cont'd)

100*	101	102	103	104	105	106	107
***** * * * * * * **** * *** *****	**** * * * * * * * * ** * **	***** * * * * * * * * ** *****	***** * * * * ** ** ** *****	***** * * * * ** * ** * ** * *****	***** ** ** ***** * * *****	***** ** ** ***** * * *	***** * * * * * * * * * * * * *****
110	111	112	113	114	115	116	117
* * * * * * ***** ** * ** * ** *	* * * ** ** ** **	* * * * * * * * * ** ** * ** *****	* * * * * * * * * ***** ** * ** * ** *	* * * ** ** ** *****	***** **** * * * * * * * * * * * * * * * *	** * * * * * * * ** * ** * ** * ** *	***** * * * * * * * * * * * * * * * *****
120	121	122	123	124	125	126	127
***** * * * * ***** ** ** **	***** * * * * * * * * * * * * *****	***** * * * * ***** ** * ** * ** *	***** * * * * ***** * * * * * * *****	***** * * * ** ** **	* * * * * * ** ** ** *****	** * ** * ** * ** * ** * * ** **	* * * * * * * * * * * * * * * * * * *****
130	131	132	133	134	135	136	137
* * * * * * **** * * ** ** ** **	* ** * ** * ** ***** ** ** **	***** * * * **** * * ** *****	***** * * * * **** ****	** ** ** * ** ** **	**** * * * * **** ****	** ** **** **** ** ** ** ** ** **	***** *****

\*OCTAL CODES

ALTERNATE CHARACTER SET (Cont'd)

140*	141	142	143	144	145	146	147
** ** **	***** * ***** ** * *****	* * ***** ** * ** * *****	***** * * * * ** * ** * *****	* * ***** * ** * ** *****	***** * * ***** ** * *****	**** * **** **** * * *	***** * * ** * ** * ***** * *****
150	151	152	153	154	155	156	157
* * ***** * * ** * ** * ** *	* * * ** ** **	* * * ** ** ** **	* * * * ** * ** * ** *	* * * ** ** **	***** **** * * * * * * * * * *	***** ** * ** * ** * ** *	***** * * ** * ** * *****
160	161	162	163	164	165	166	167
***** * * ** * ** * ***** * *	***** * * ** * ** * ***** * *	***** * ** ** **	***** * ***** ** *****	* * ***** ** **	* * * * ** * ** * ***** **	* * ** * * * ** * **	* * * * * * * * * * * * ***** *****
170	171	172	173	174	175	176	177
* * * * *** * ** * **	** * ** * * * ** * ***** **	***** * ** * *****	*** * *** * *** ***	** ** ** ** ** **	*** * *** *** * *** ***	** * * ** **	* ***** * ** * ***** *

\* OCTAL CODES